

Best Available Copy

1/43

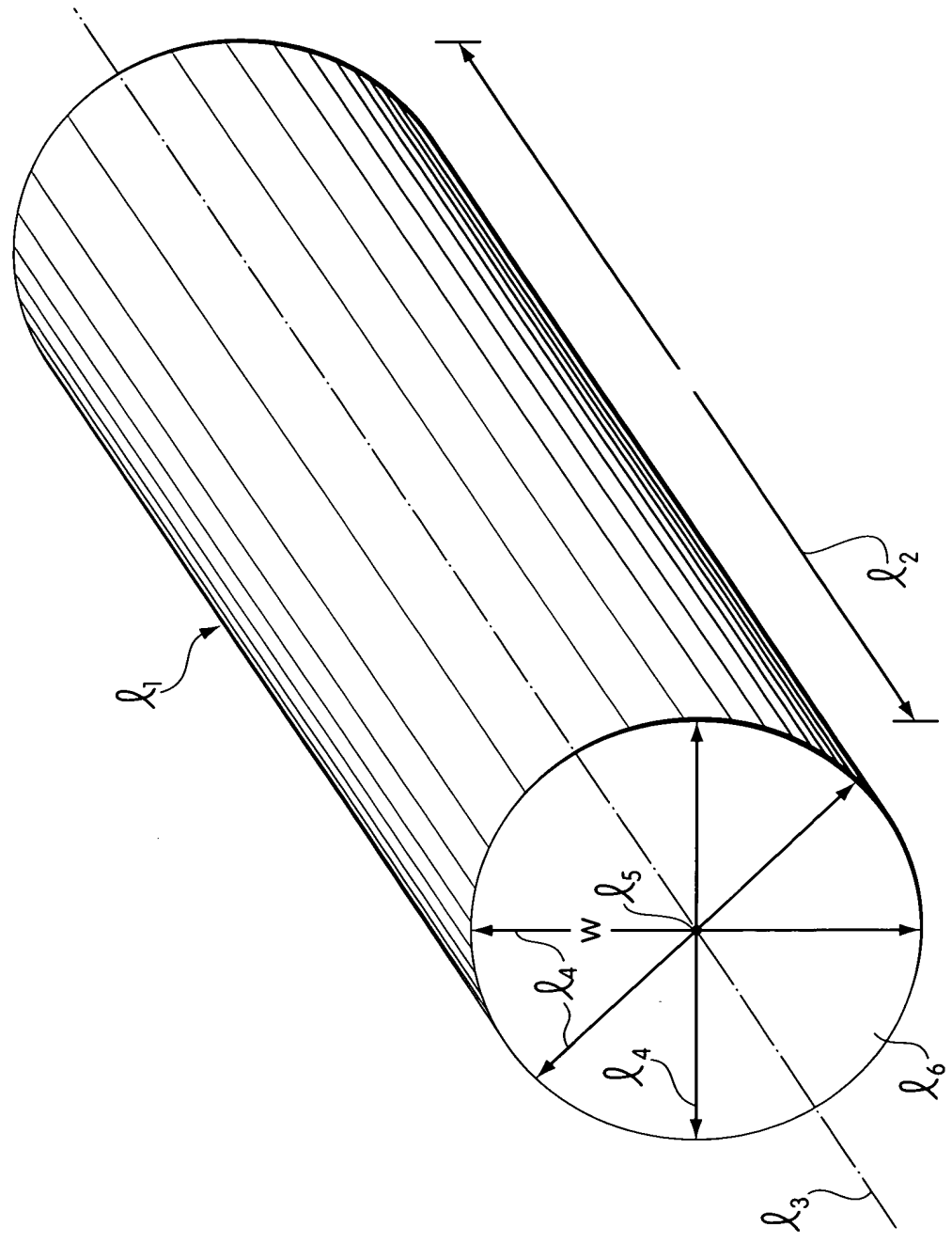

Fig. 1

09935776 "OFFICE"

20250922

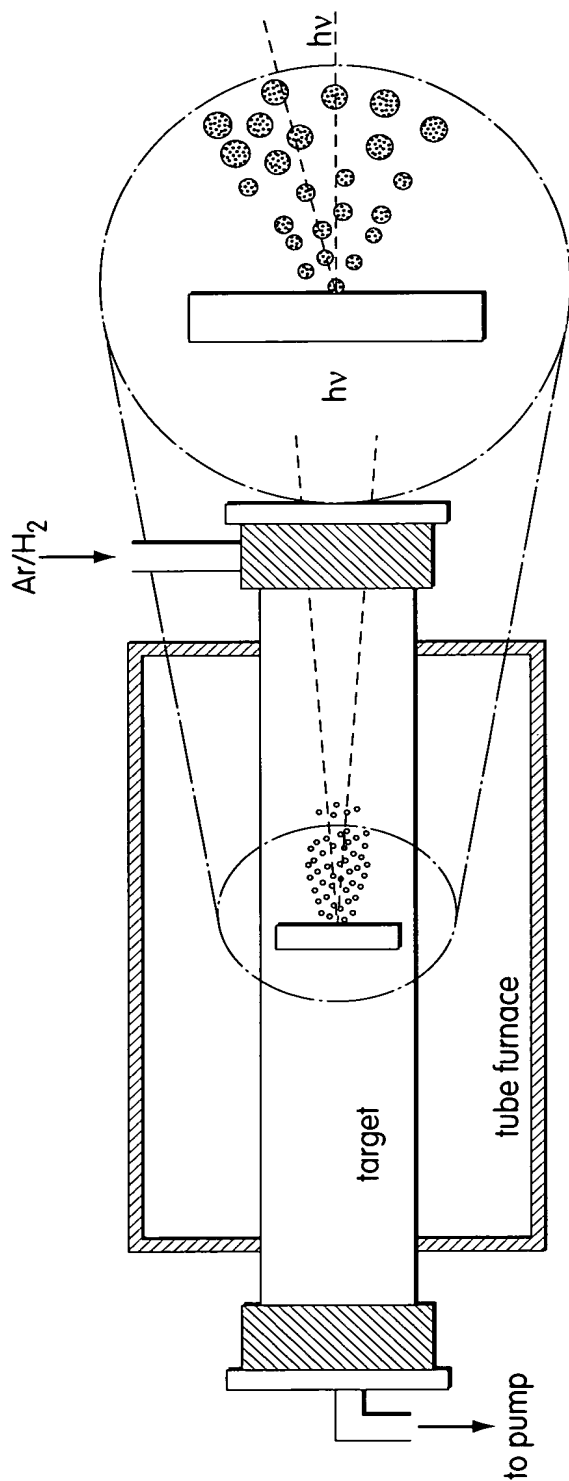

Fig. 2

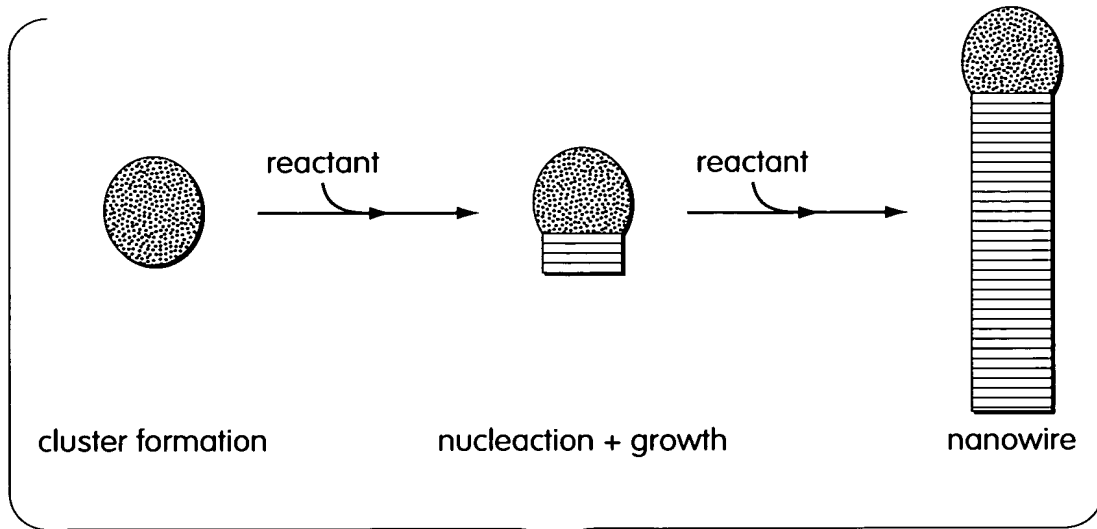

Fig. 3

20250925092509

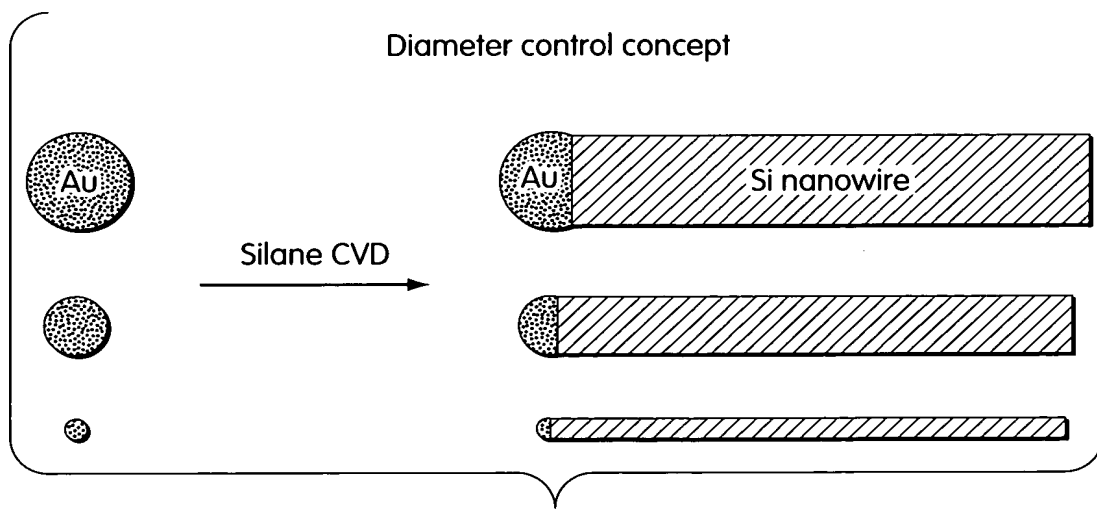

Fig. 4

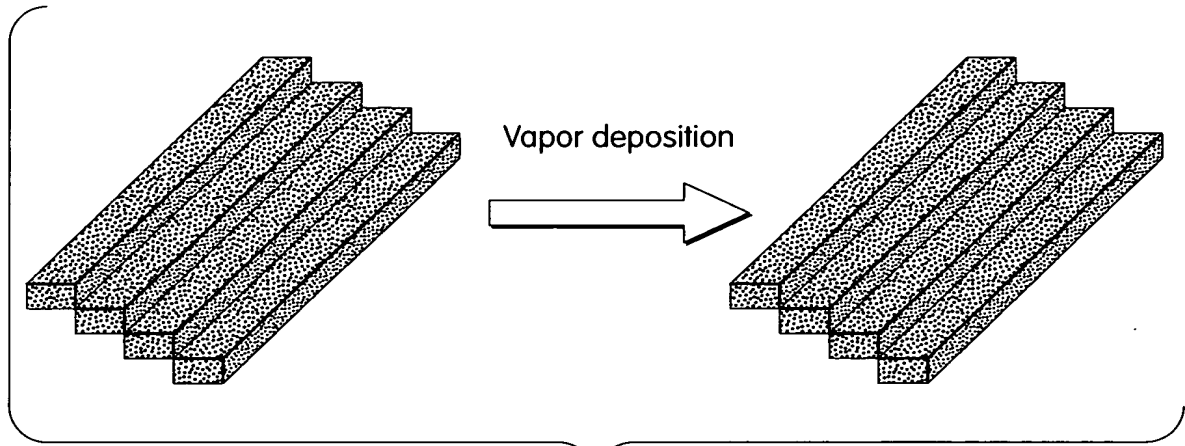

Fig. 5

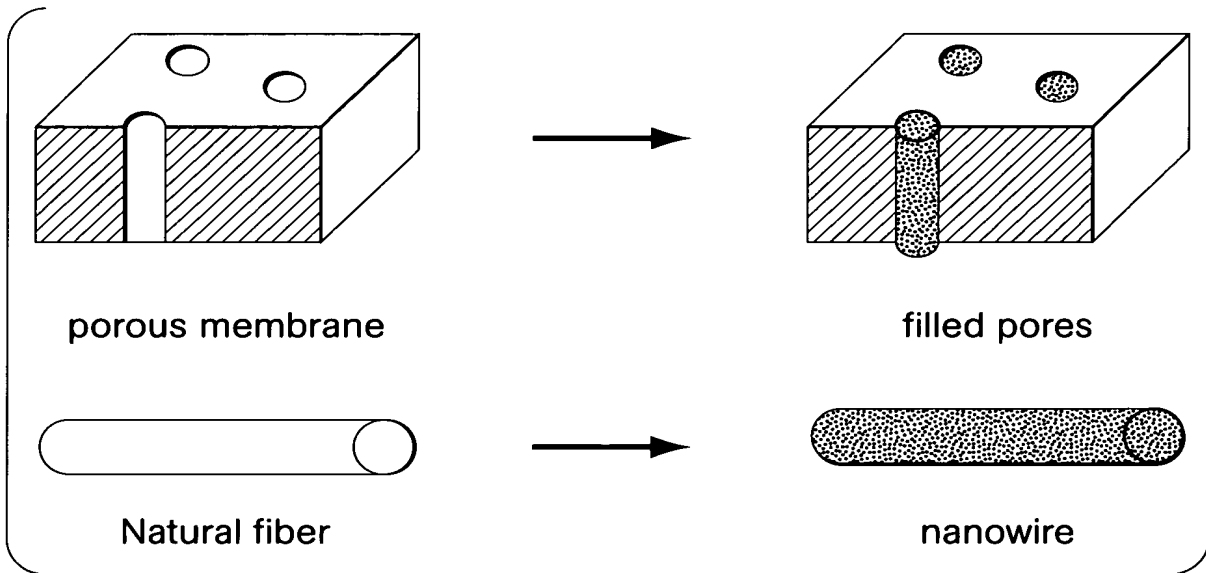

Fig. 6

20250924 9:45:56

5/43

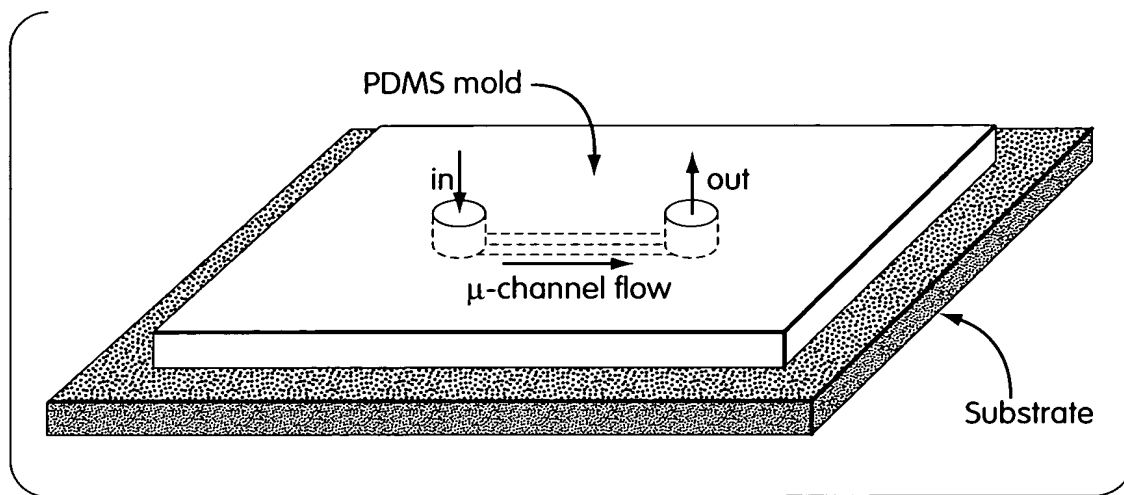

Fig. 7A

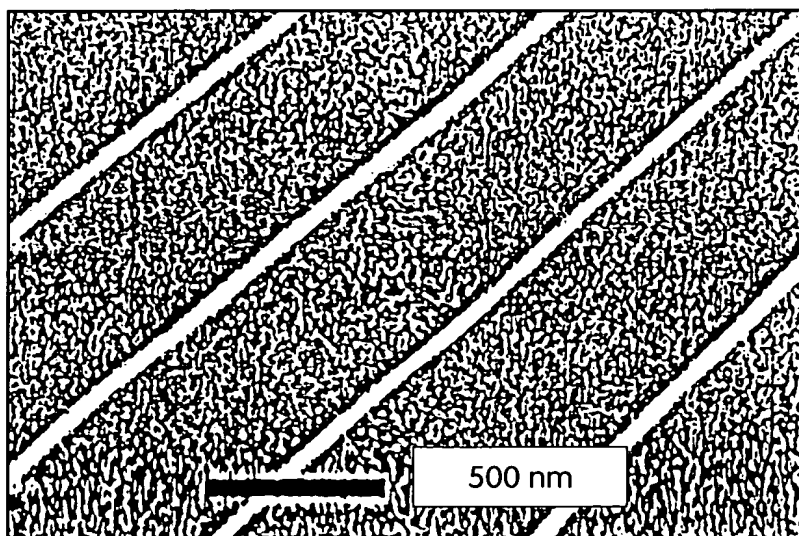
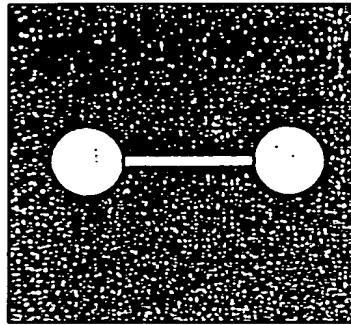

Fig. 7B

20250716 09:57:03

6/43



First layer

Fig. 7C

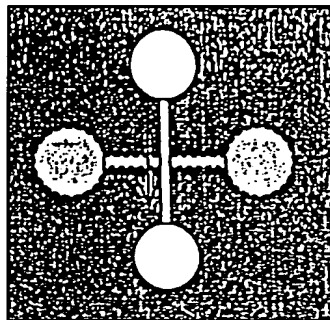

Second layer

Fig. 7D

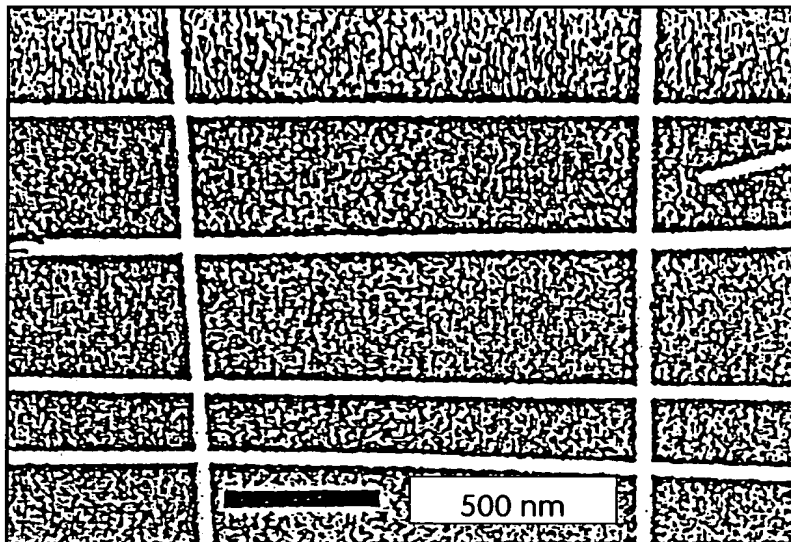

Fig. 7E

099576-03100  
"REF ID: A56660"

7/43

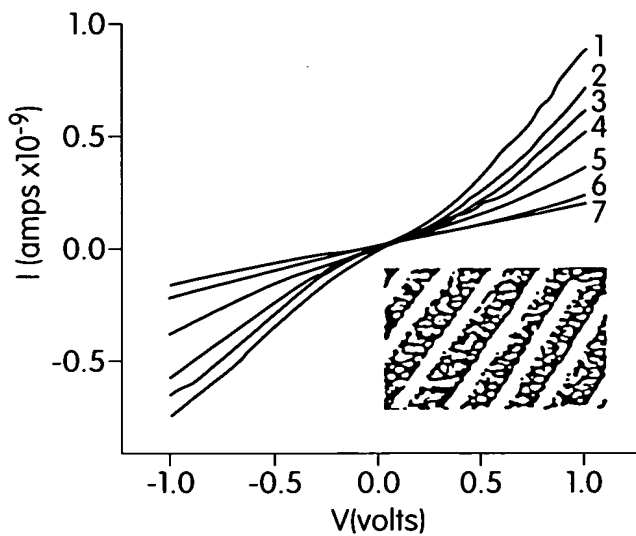

Fig. 8A

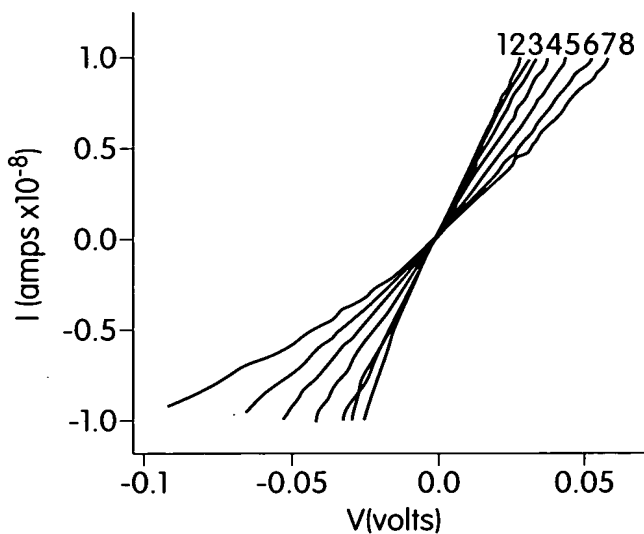

Fig. 8B

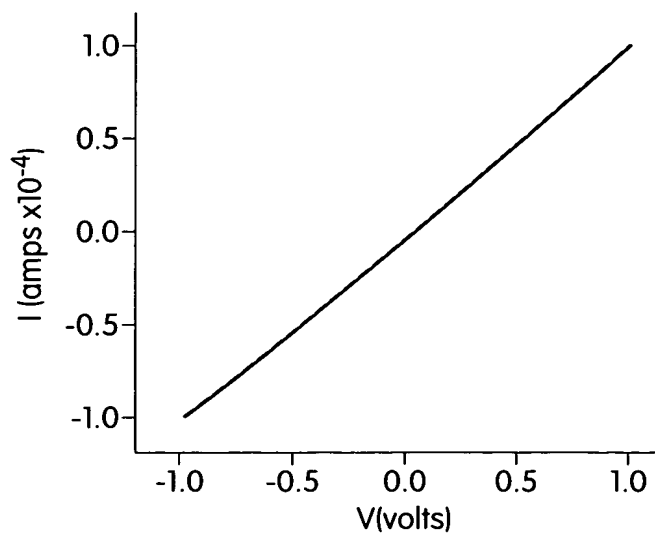

Fig. 8C

20250925E660

8/43

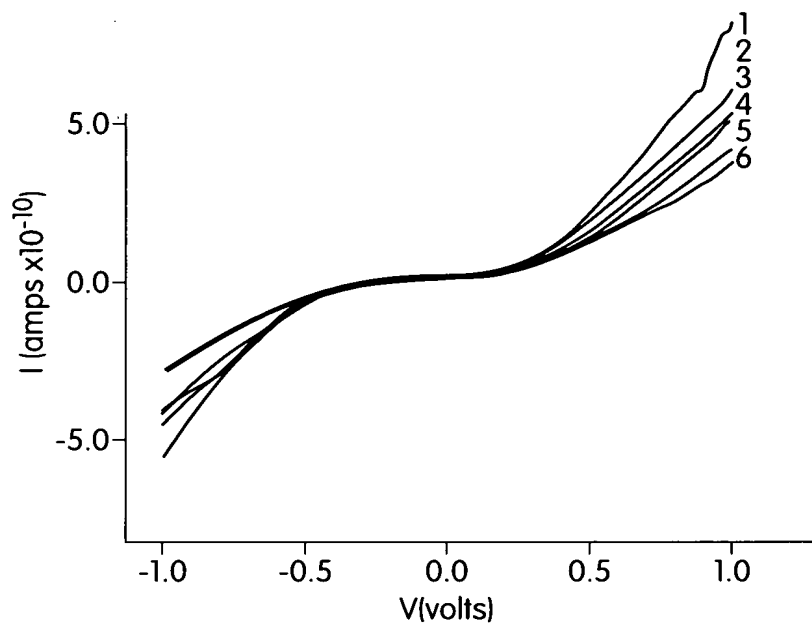

Fig. 9A

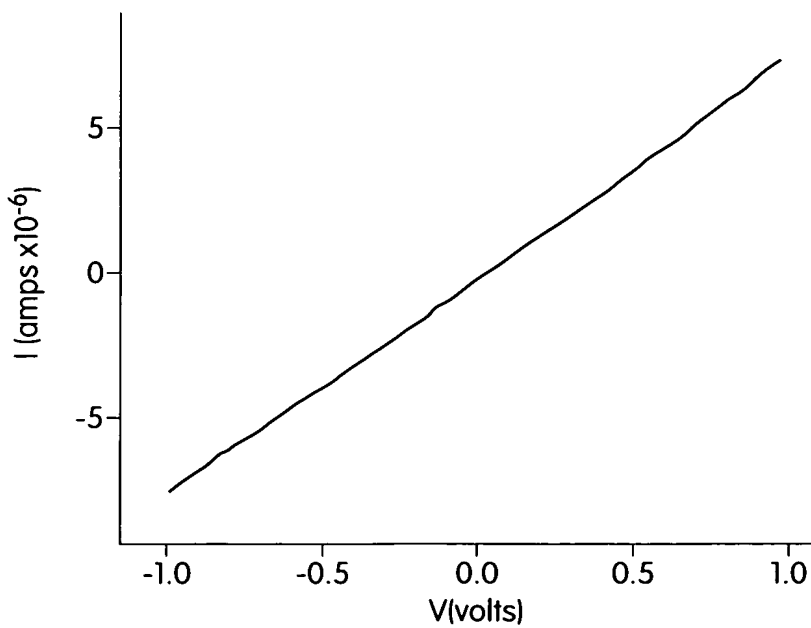

Fig. 9B

202509250550



9/43

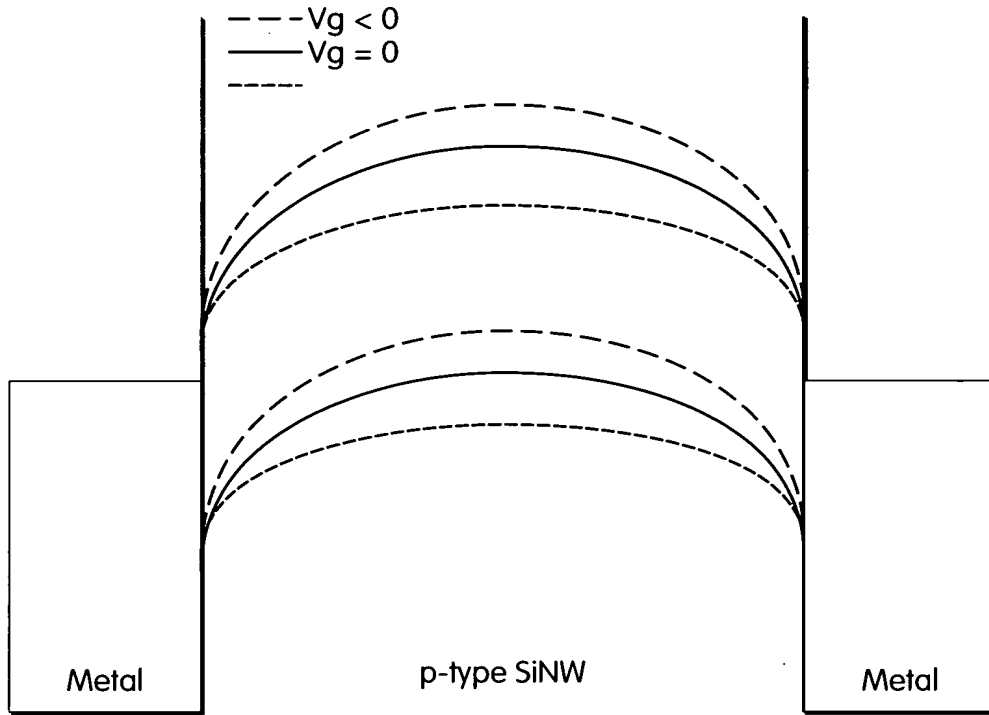

Fig. 10A

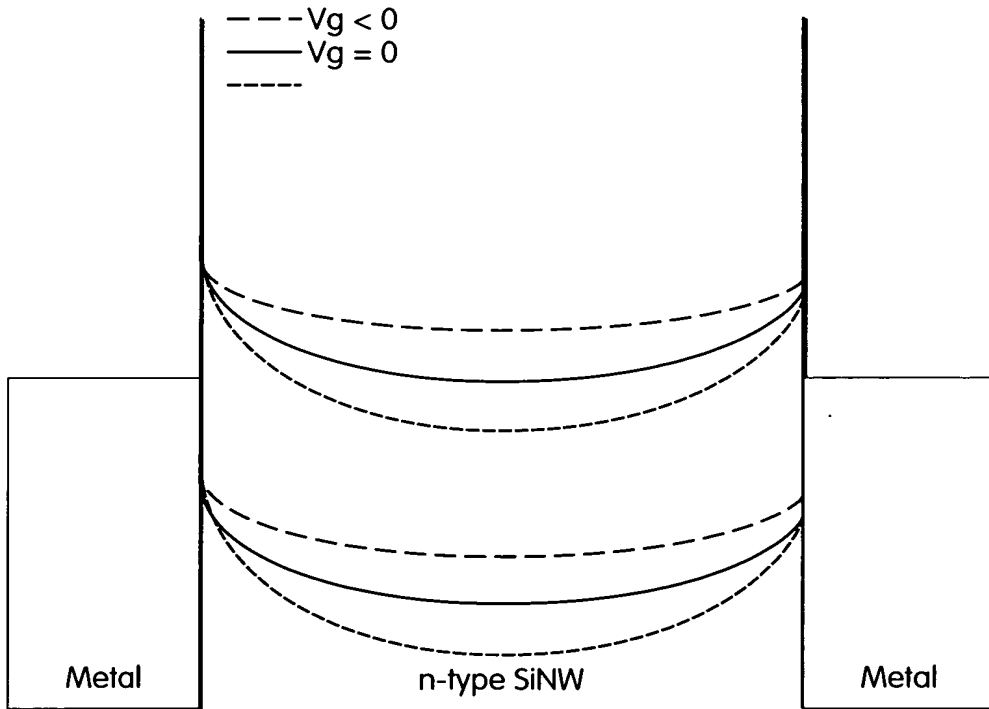

Fig. 10B

20250924 09:56:50

10/43

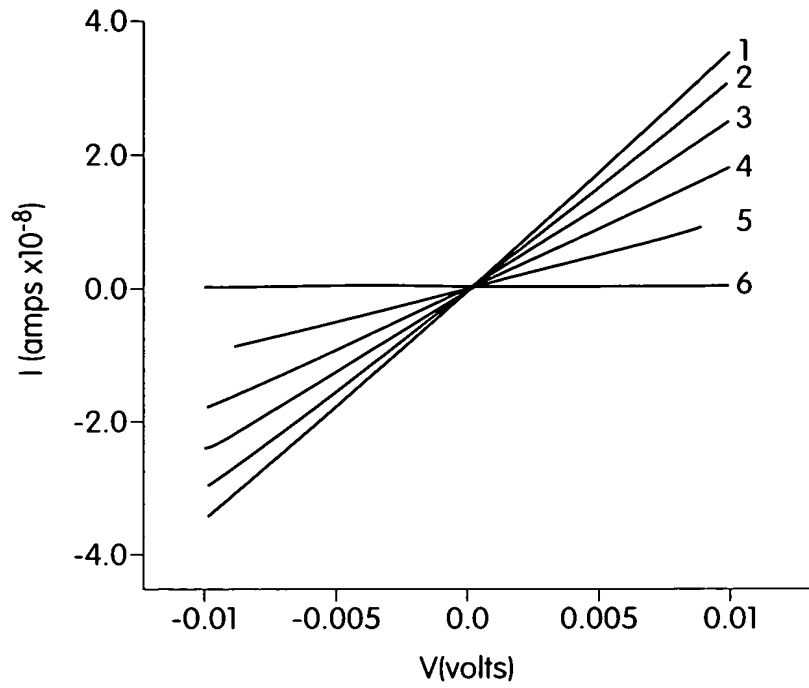

Fig. 11A

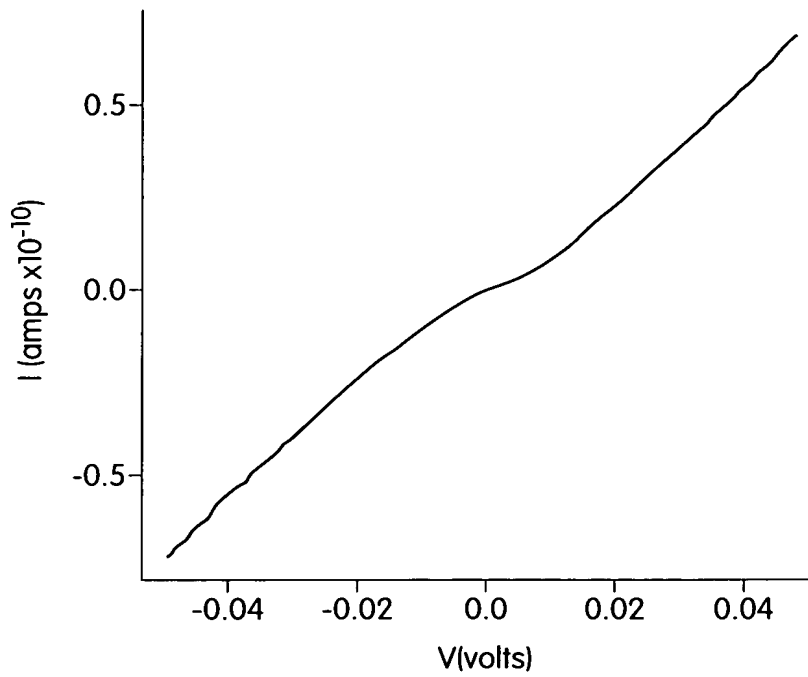

Fig. 11B

RECEIVED 9/25/60

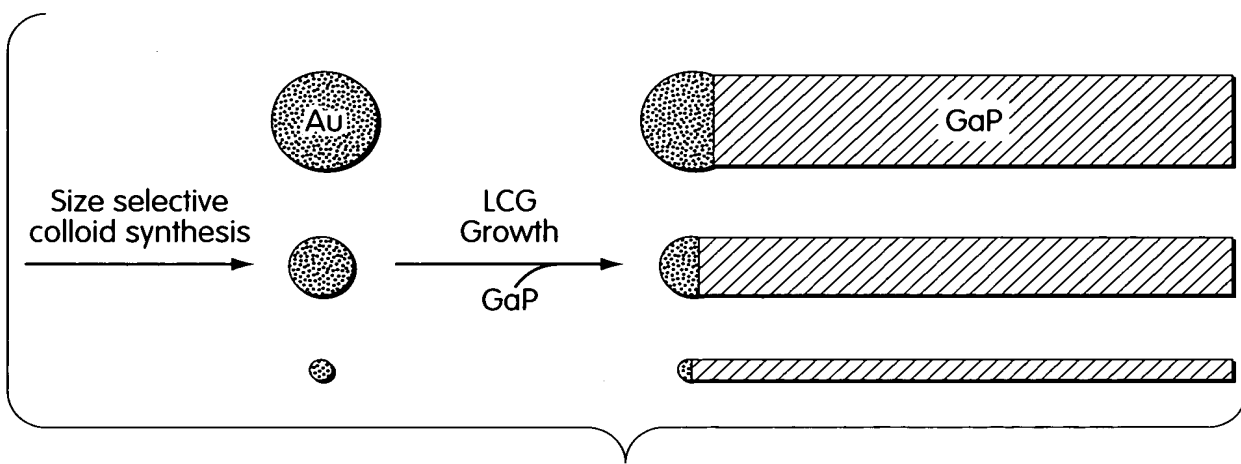

Fig. 12

ACCEPTED MANUSCRIPT

12/43

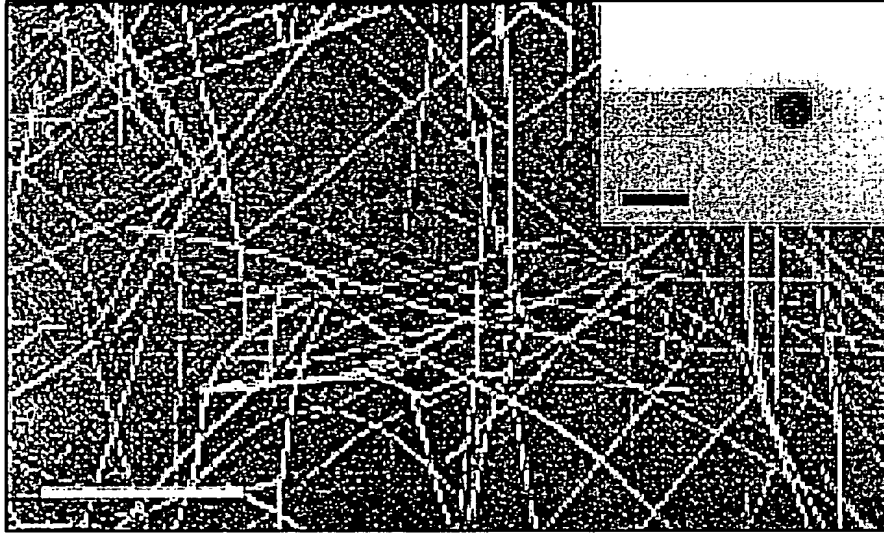

Fig. 13A

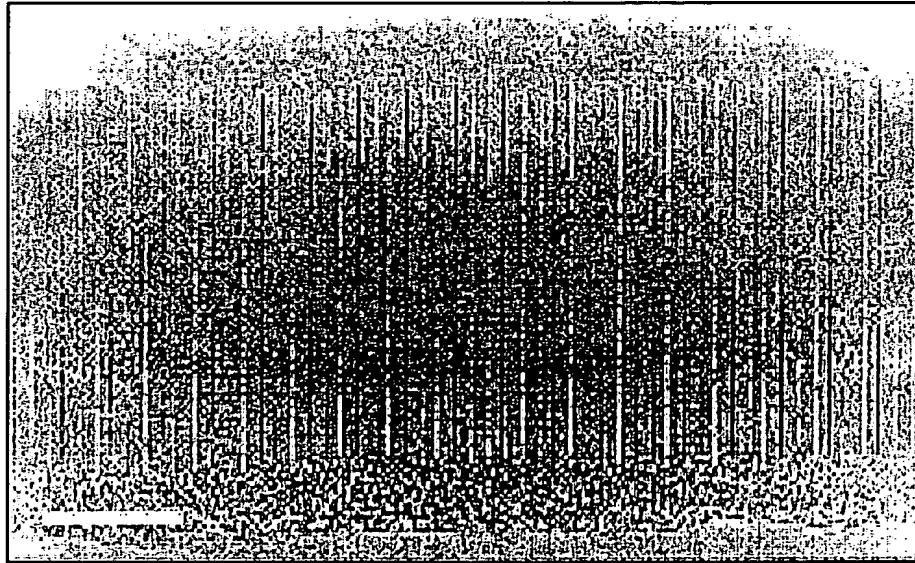

Fig. 13B

2027E0" 9/25E660

13/43

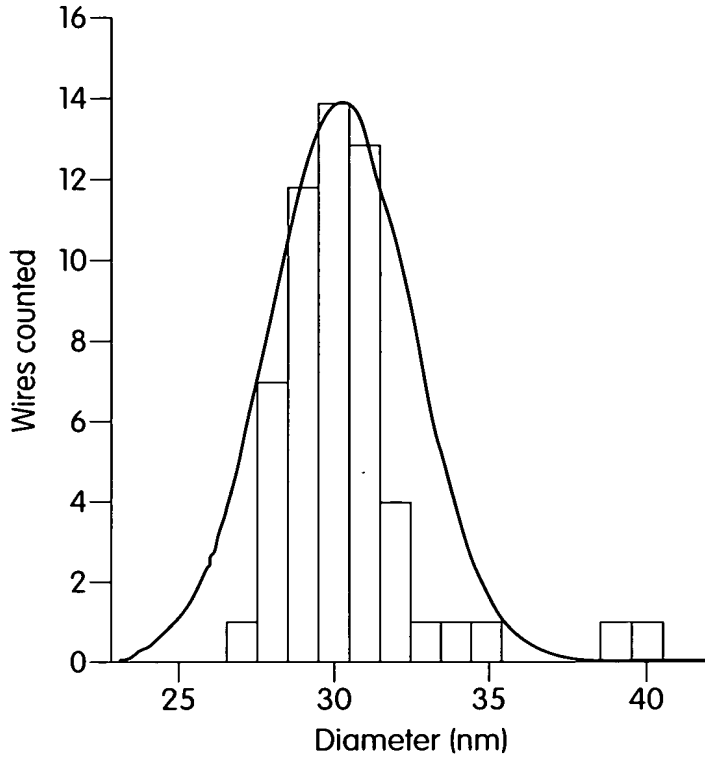

Fig. 14A

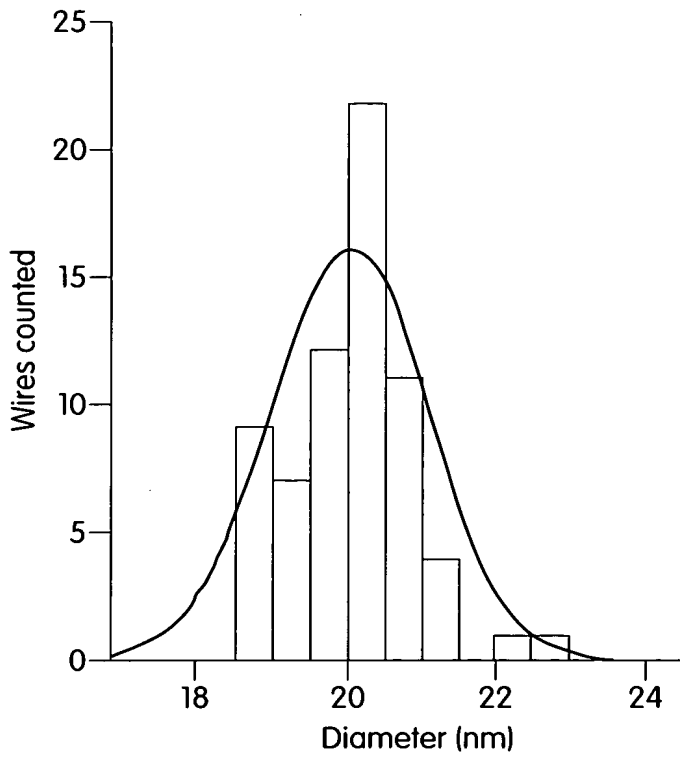

Fig. 14B

REF ID: A45660

14/43

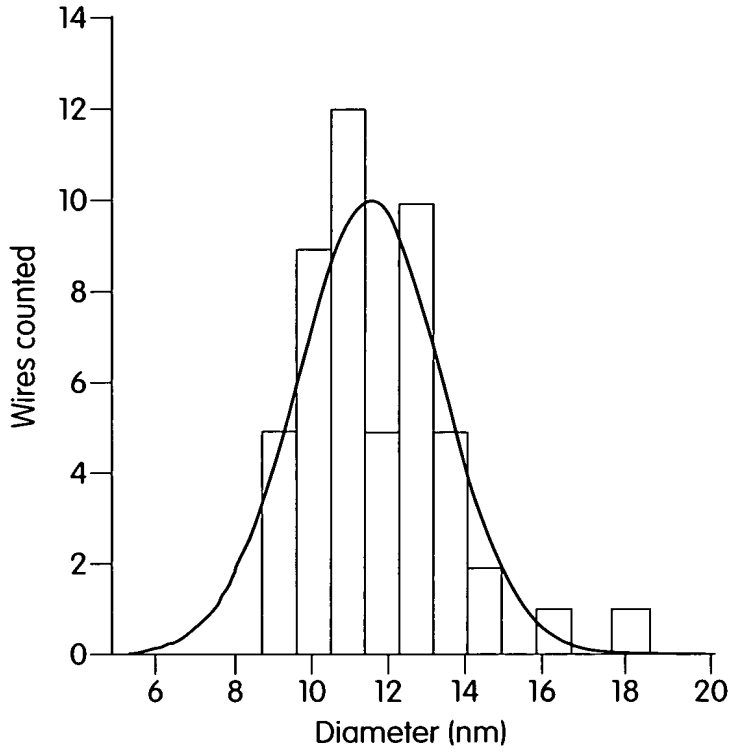

Fig. 14C

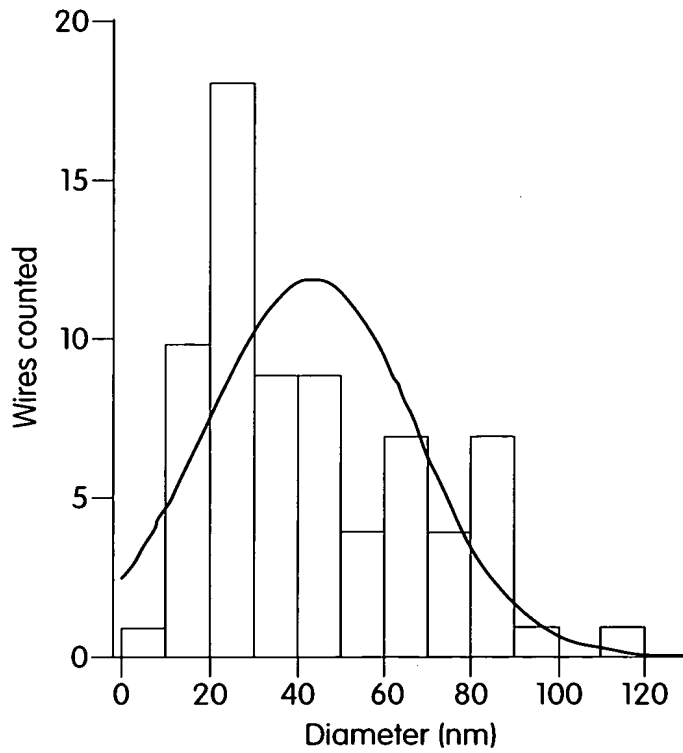

Fig. 14D

REF ID: A25660

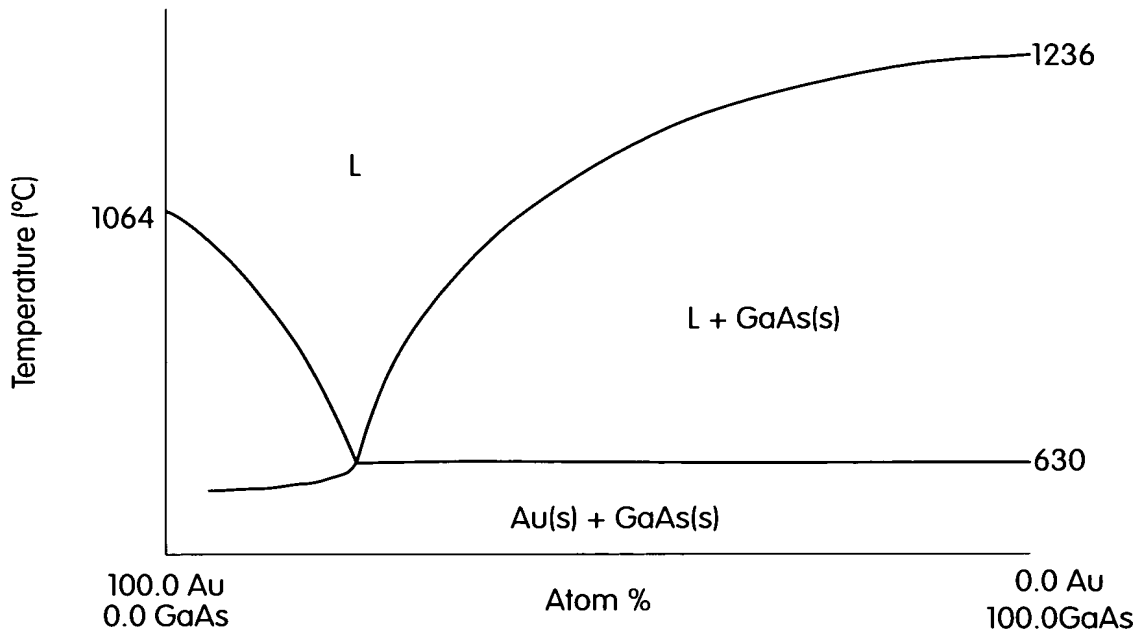

Fig. 15

202509225660

16/43

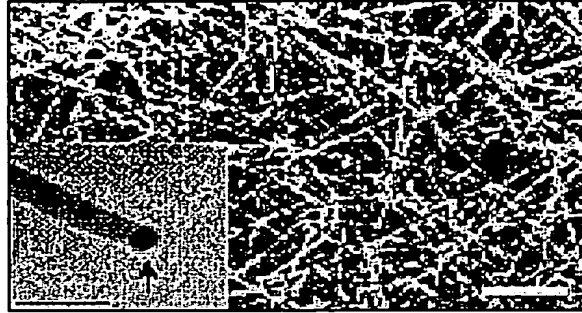

Fig. 16A

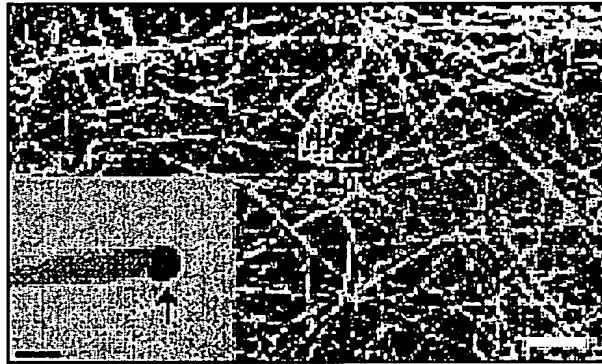

Fig. 16B

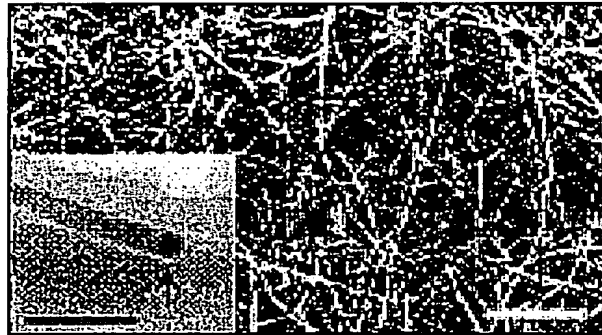

Fig. 16C

09935776.031202



17/43

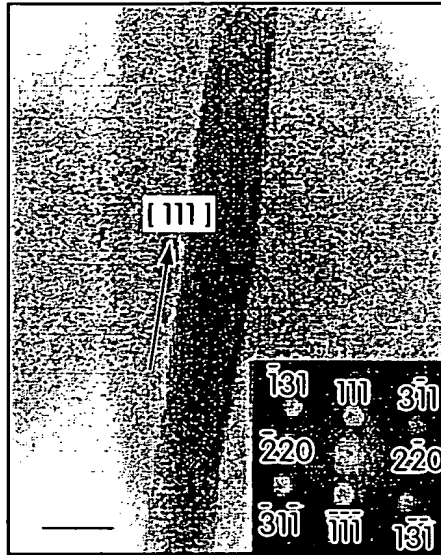

Fig. 17A

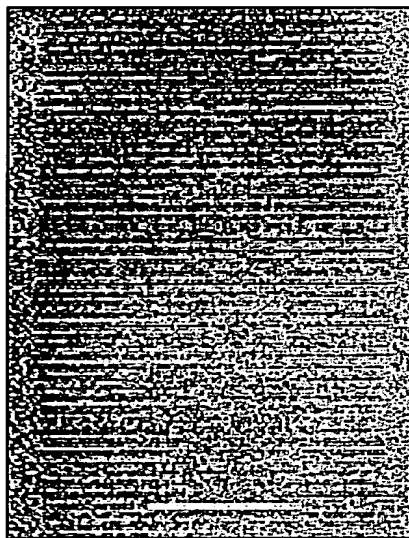

Fig. 17B

20250915 09:56:50

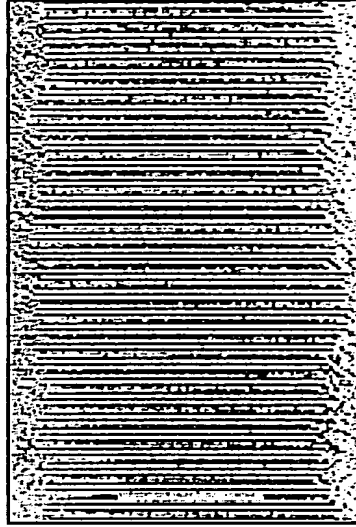

Fig. 17C

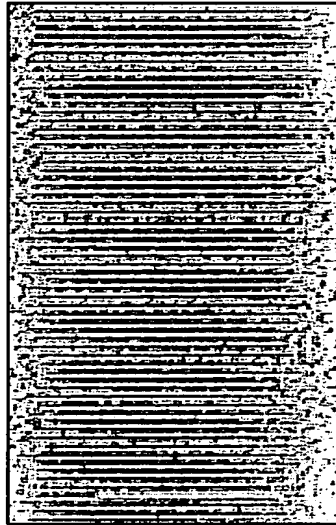

Fig. 17D

09935776 " 031202  
2021E0" 9/25E660

19/43

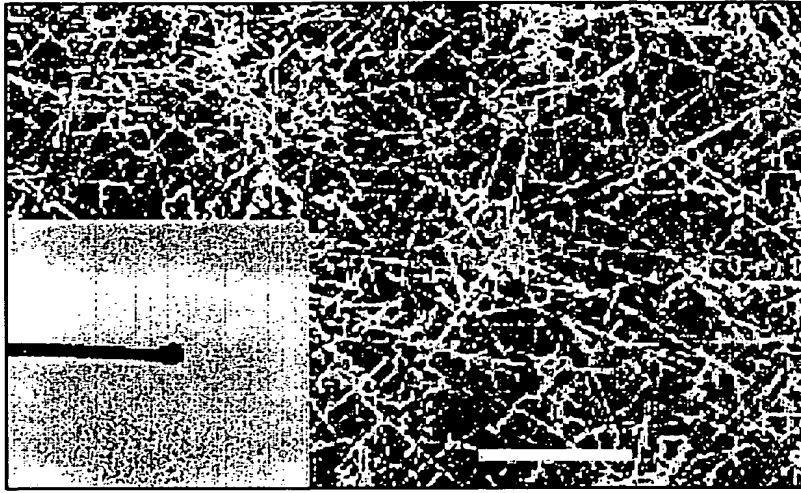

Fig. 18A

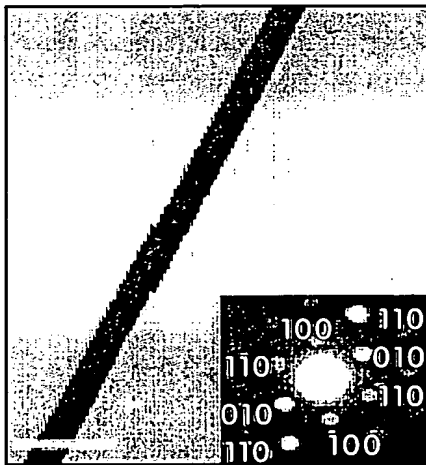

Fig. 18B

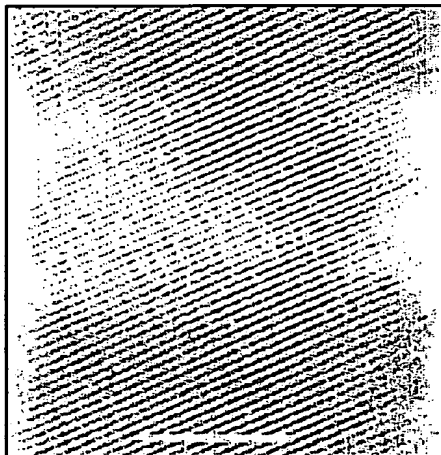

Fig. 18C

202FE0" 9/25E660

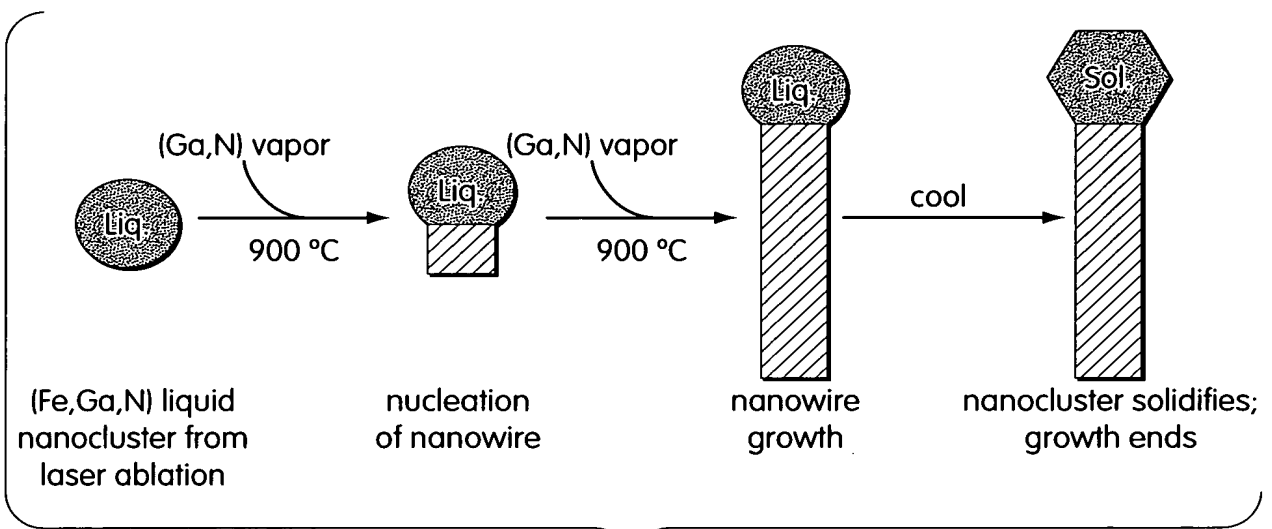

Fig. 19

20250922 9:25:50

21/43

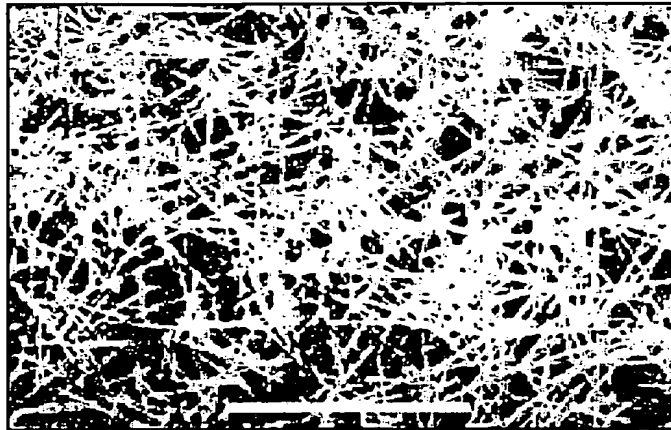

Fig. 20A

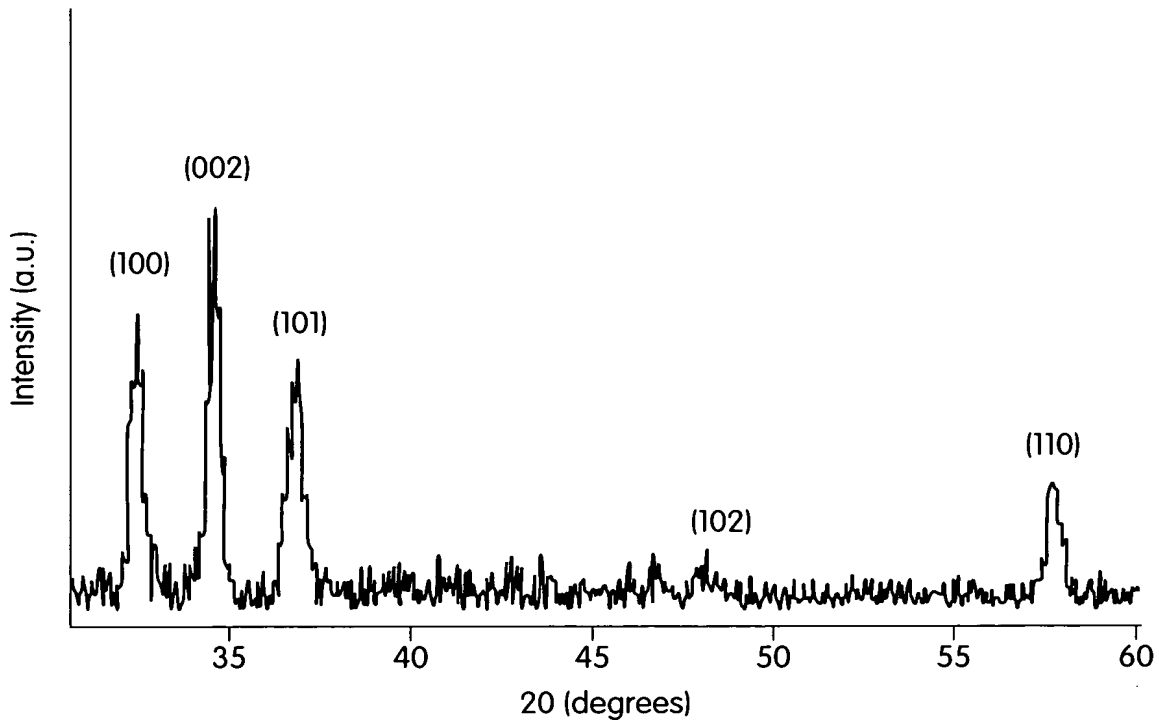

Fig. 20B

202FE0" 9225E660

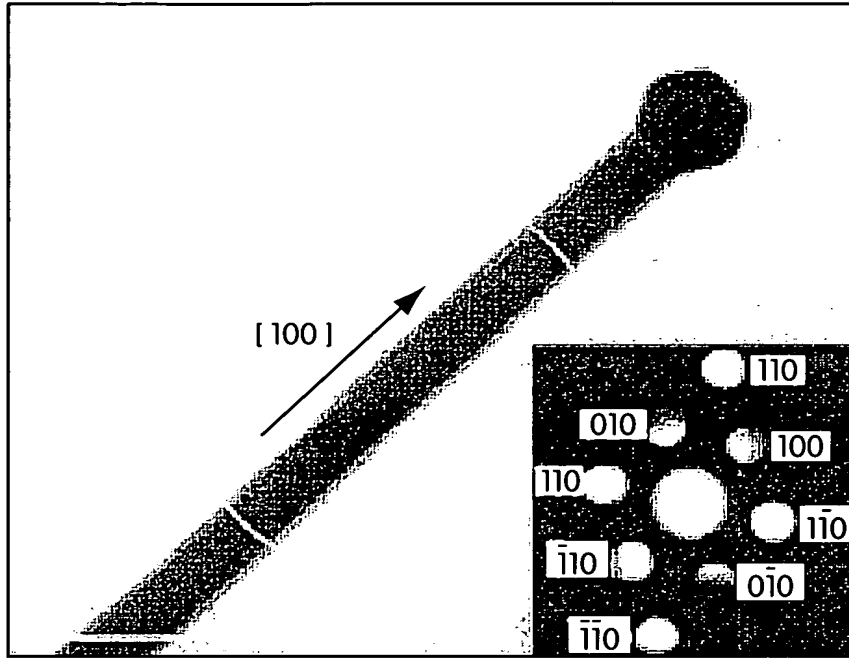

Fig. 21A

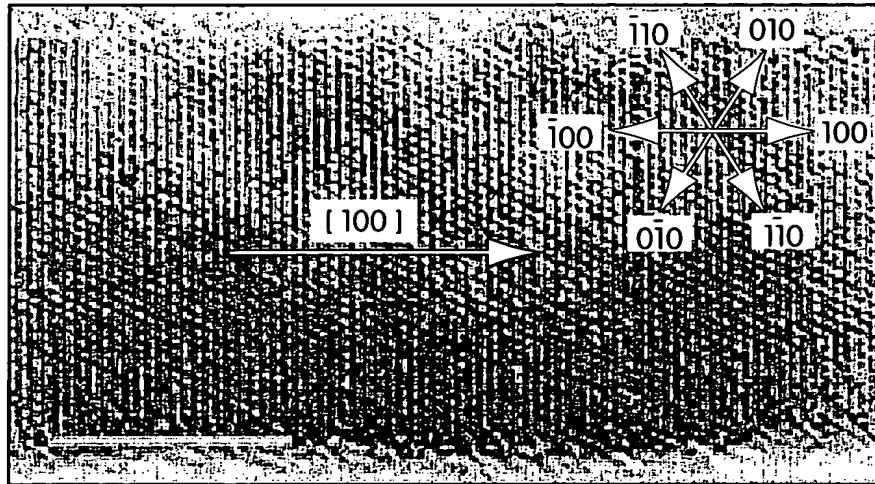

Fig. 21B

20250927 09:25:660

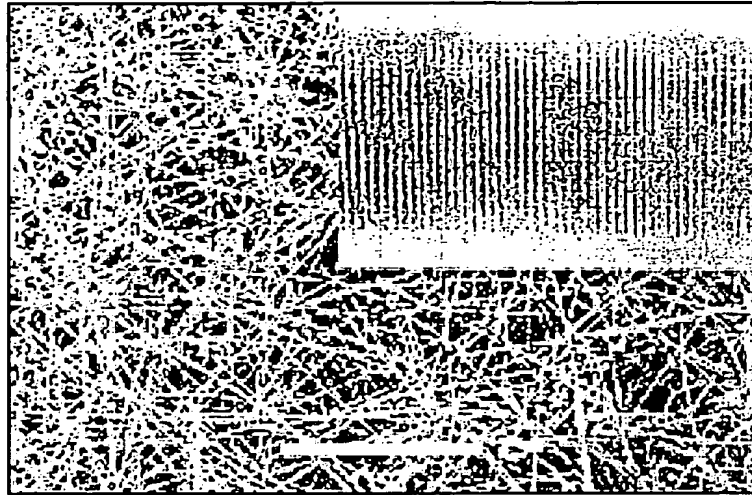

Fig. 22A

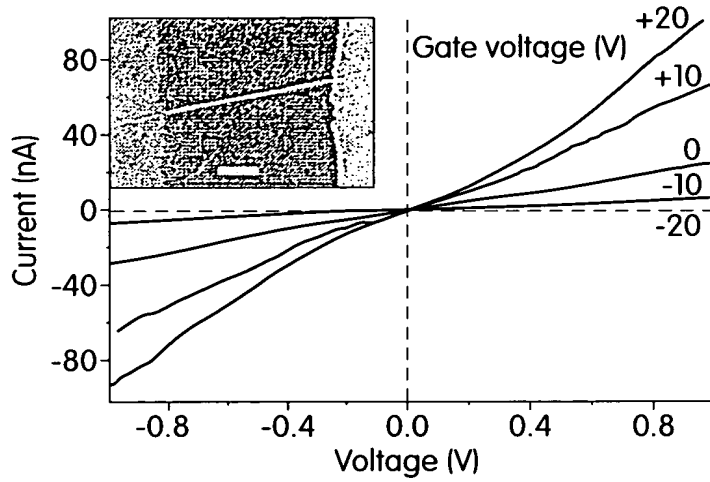

Fig. 22B

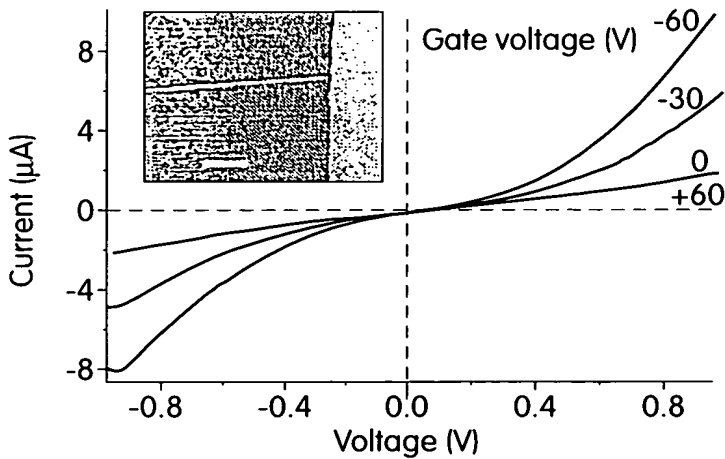

Fig. 22C

202509 925660

24/43

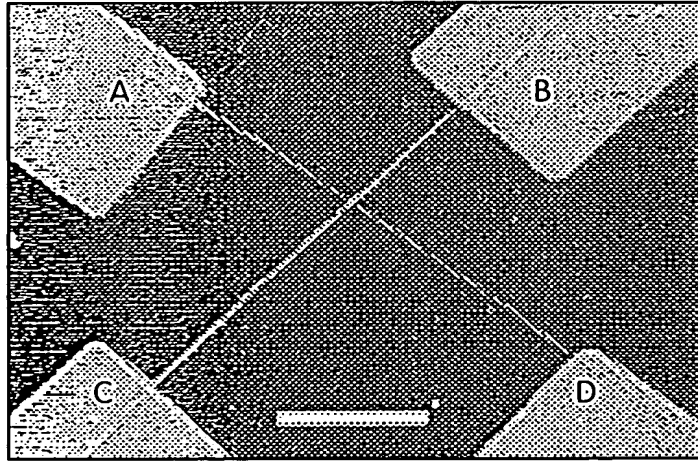

Fig. 23A

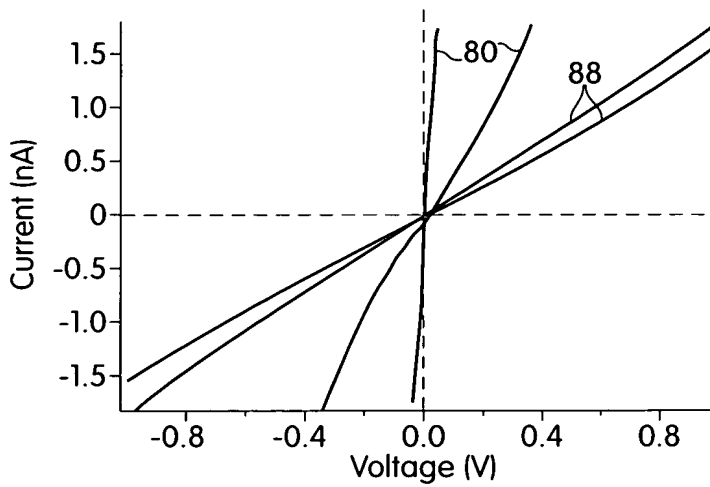

Fig. 23B

202509251660



25/43

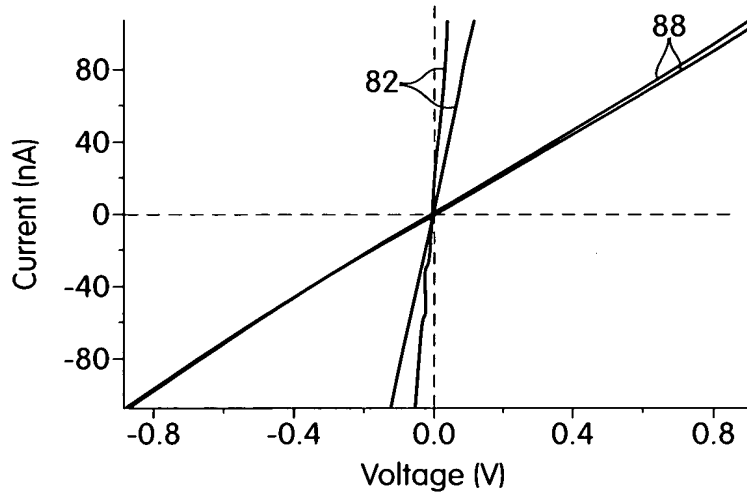

Fig. 23C

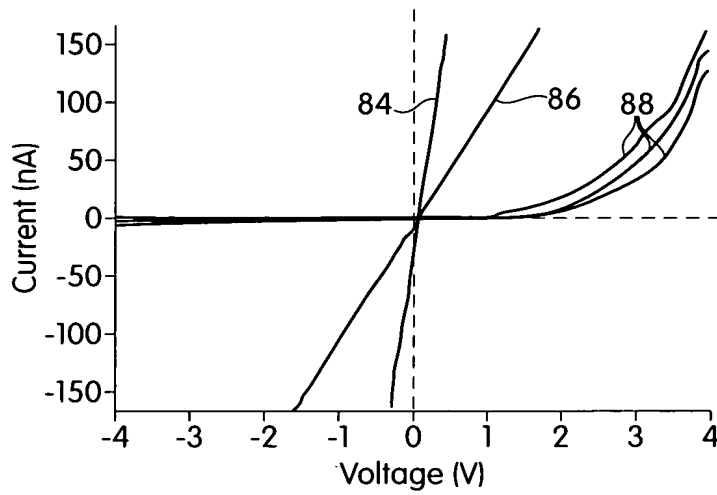

Fig. 23D

REF ID: A25660

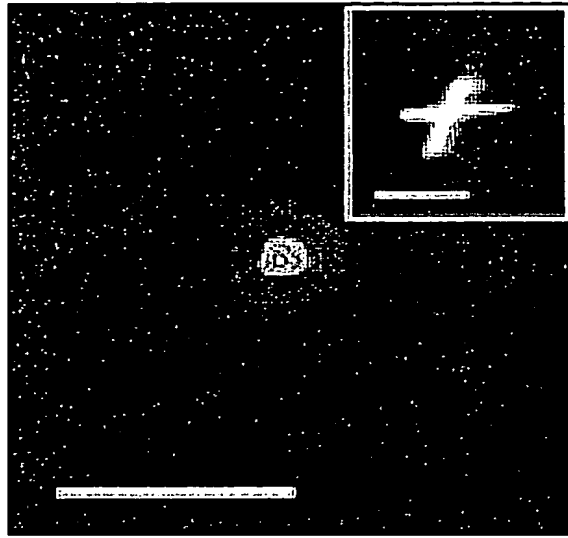

Fig. 24A

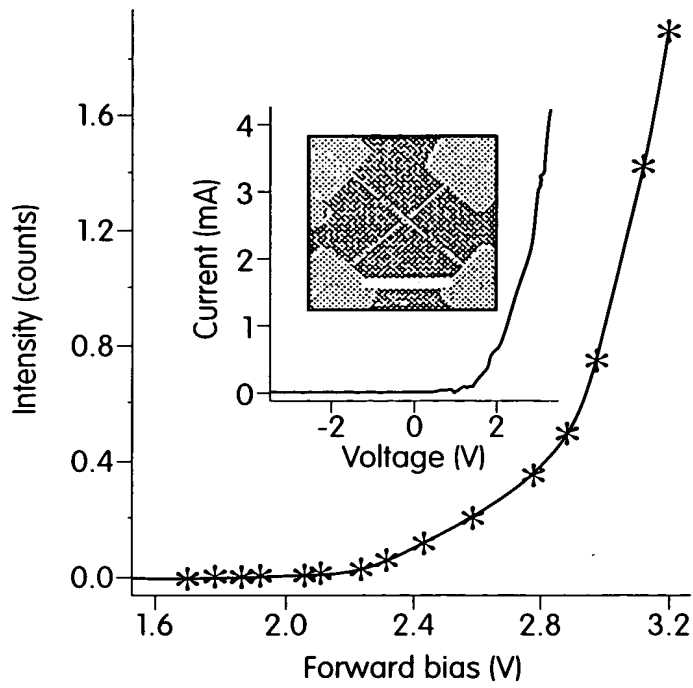

Fig. 24B

202509225E660

27/43

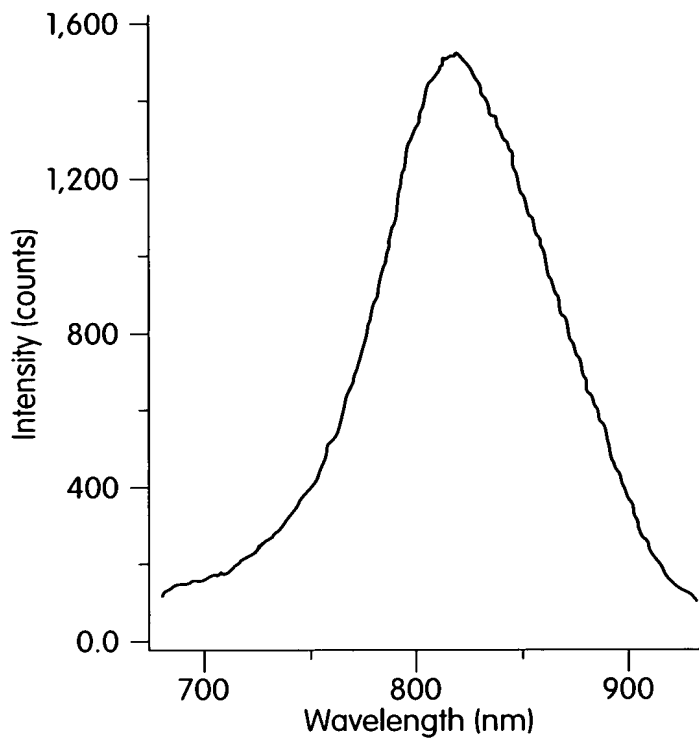

Fig. 24C

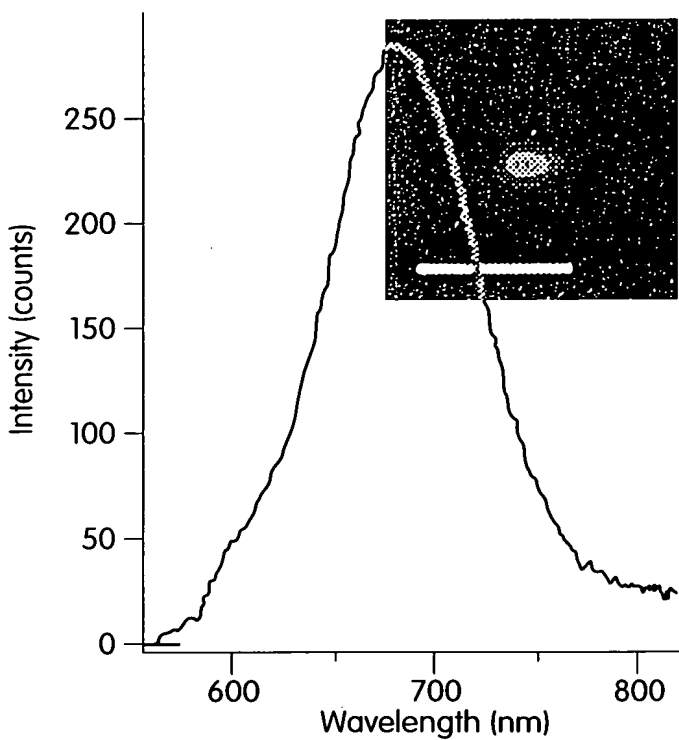

Fig. 24D

20250922 09:56:10

28/43

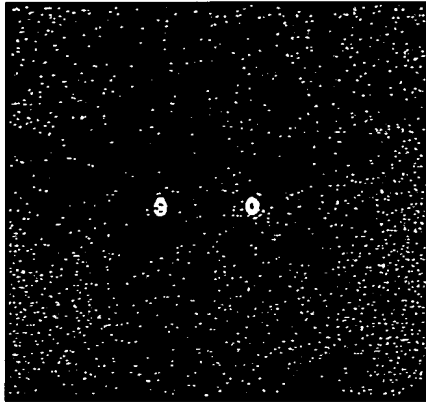

Fig. 25A

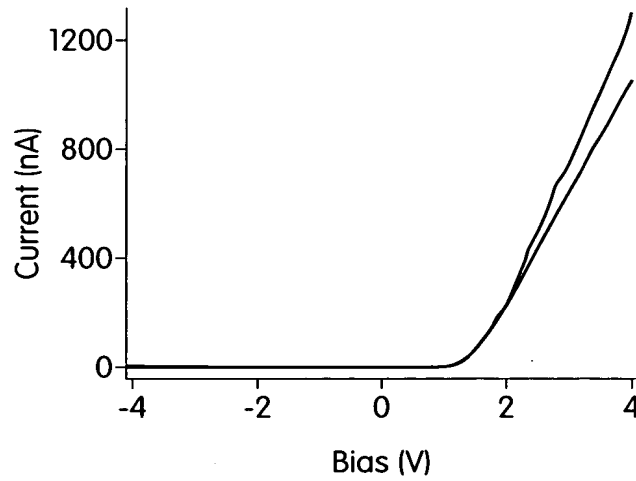

Fig. 25B

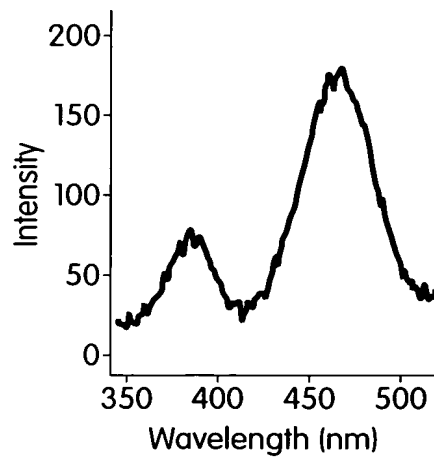

Fig. 25C

20250709 92252660

29/43

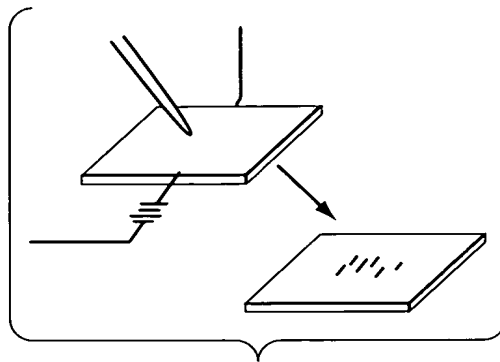

Fig. 26A

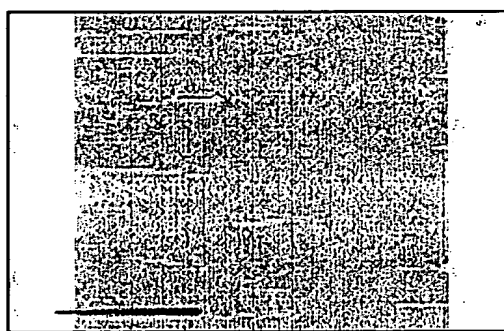

Fig. 26B

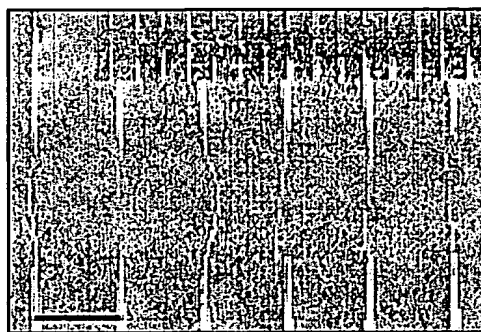

Fig. 26C

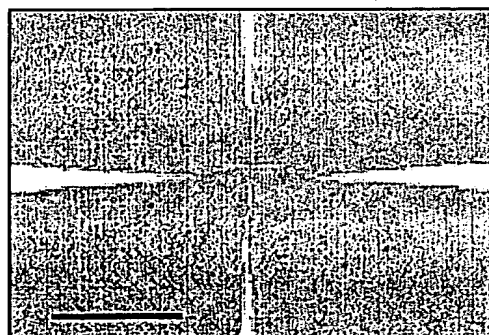

Fig. 26D

2027E0" 9225E660

30/43

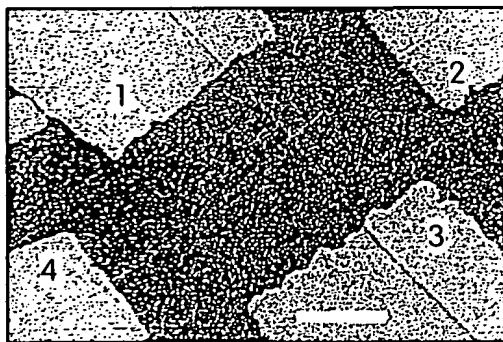

Fig. 27A

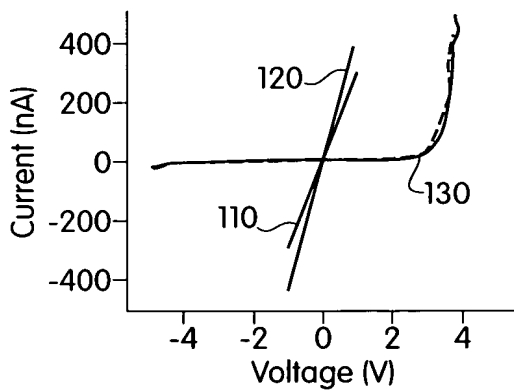

Fig. 27B

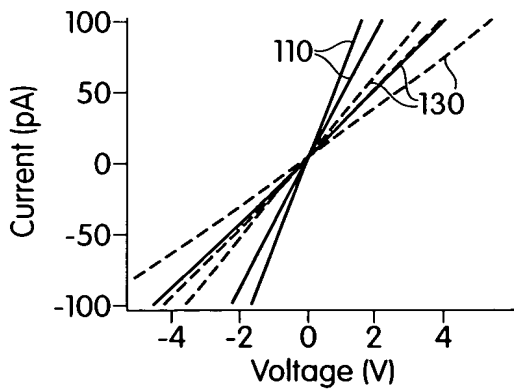

Fig. 27C

202509225560

31/43

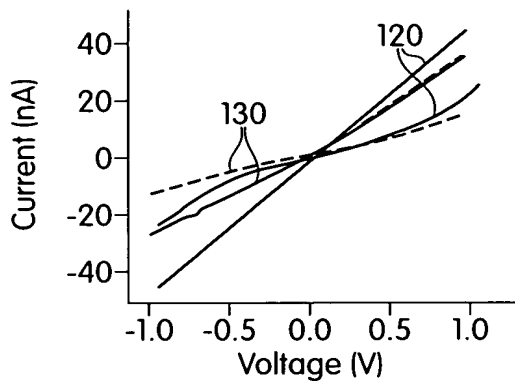
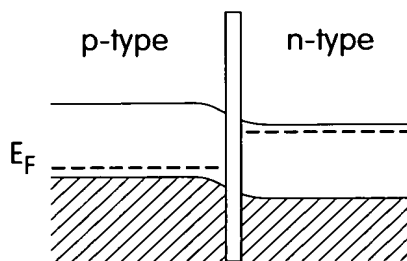
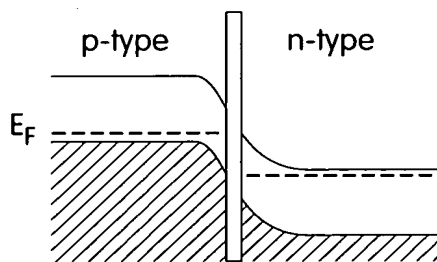

Fig. 27D



Forward bias

Fig. 27E



Reverse bias

Fig. 27F

2025092500

32/43

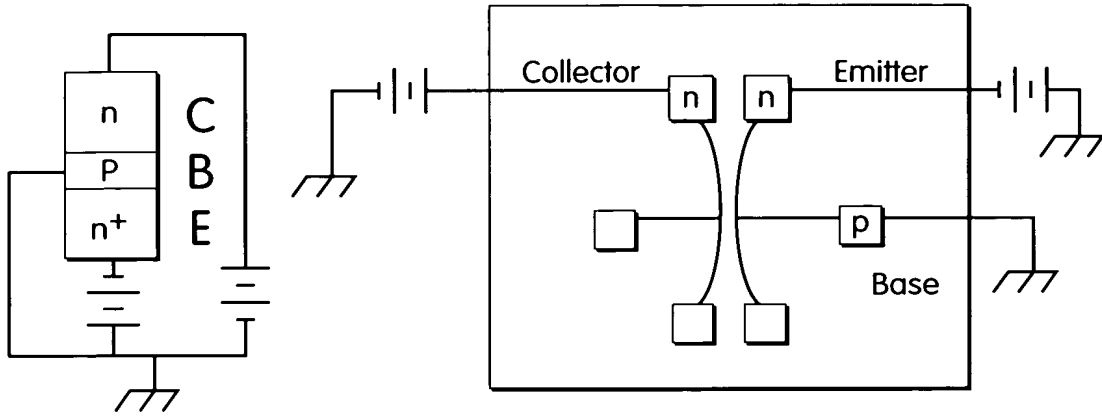

Fig. 28A

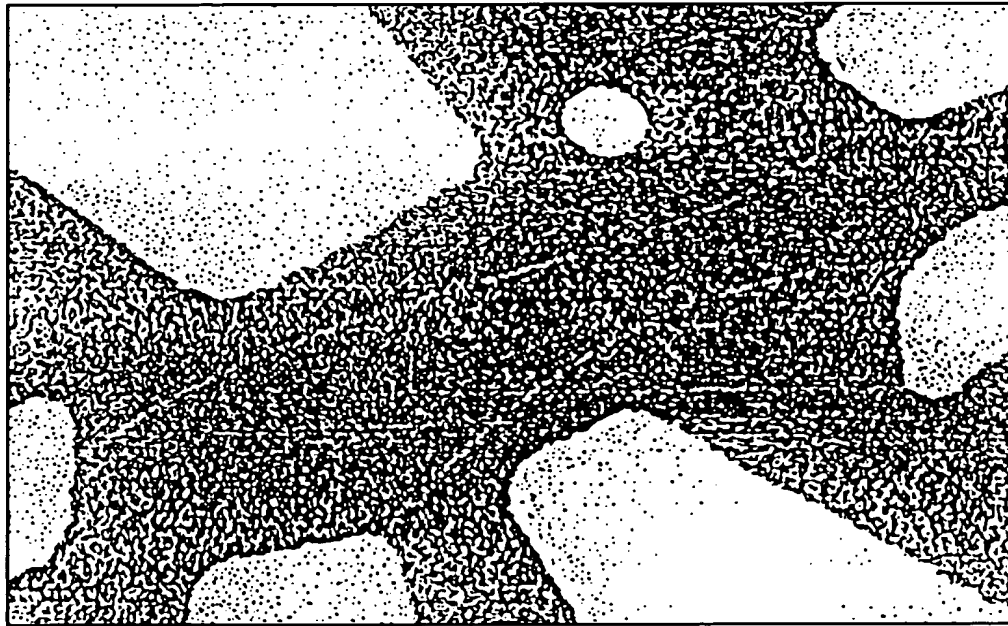

Fig. 28B

2021E0 9225E660



33/43

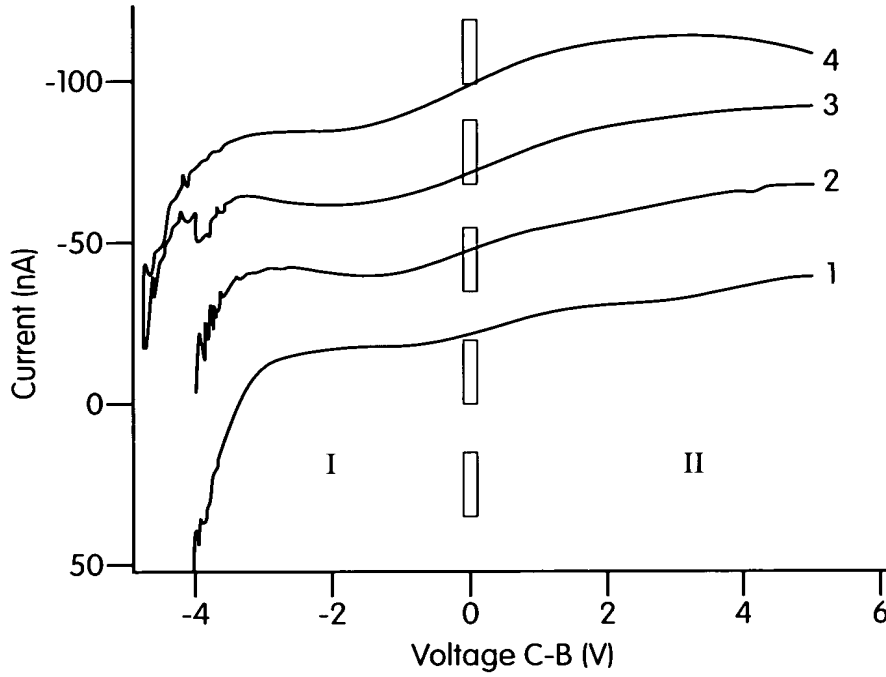

Fig. 28C

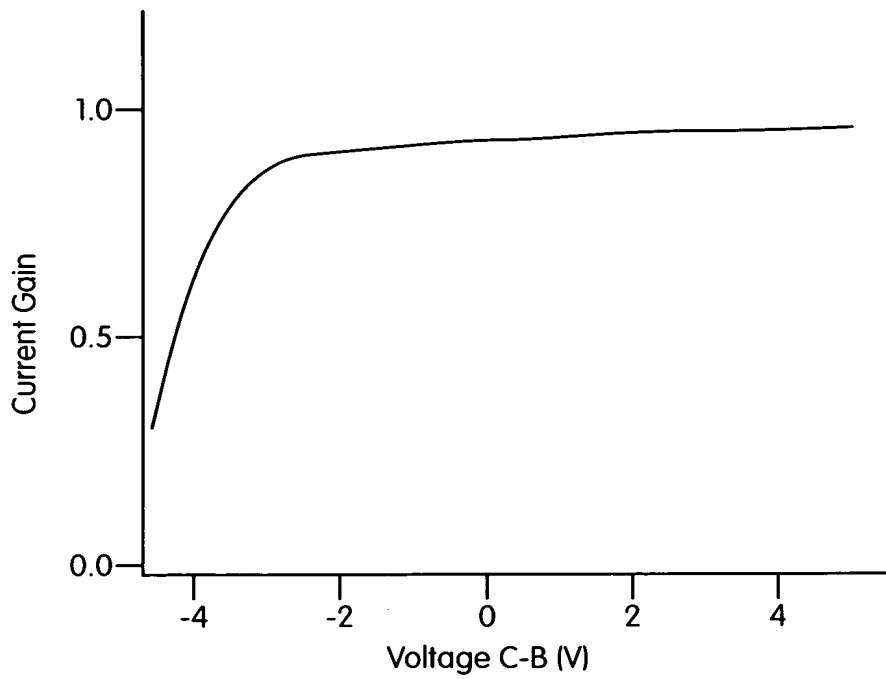

Fig. 28D

REF ID: A25660

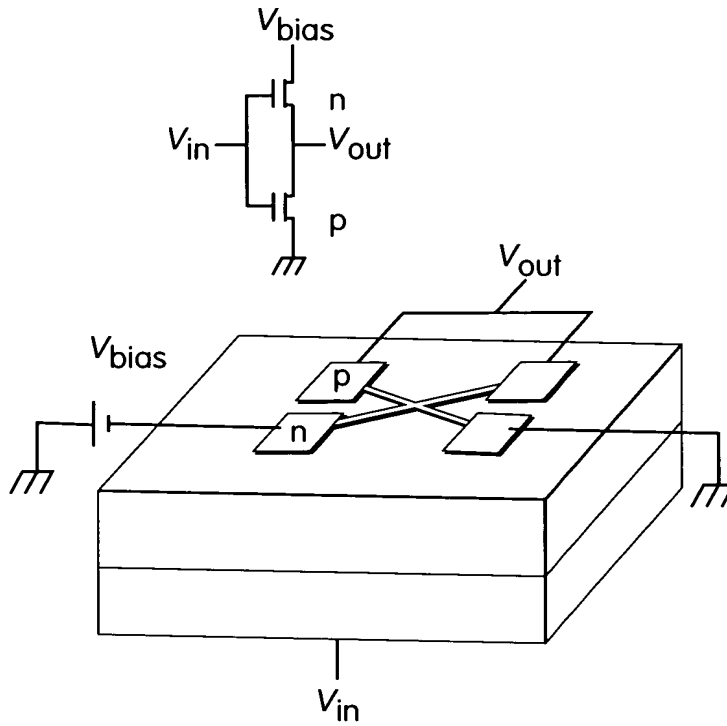

Fig. 29A

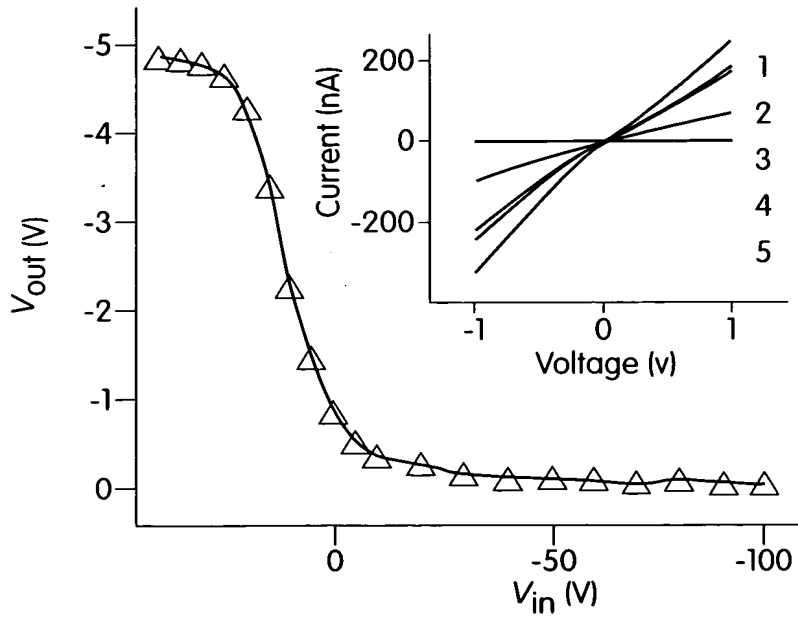

Fig. 29B

PHOTO 925E60

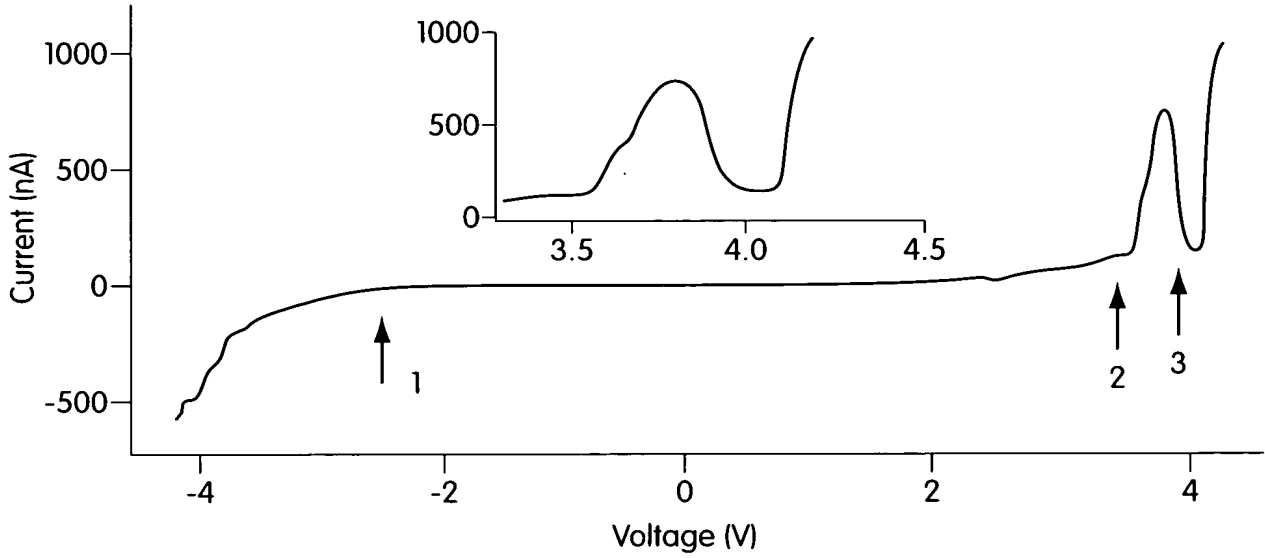

Fig. 29C

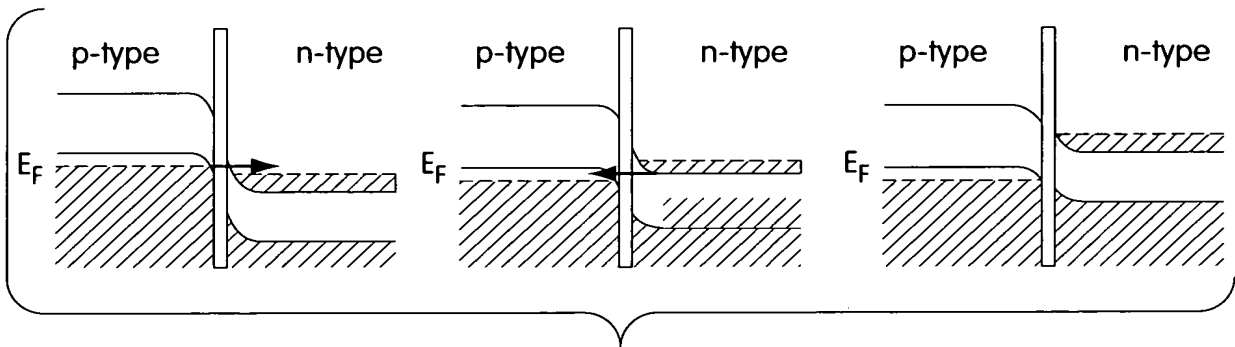

Fig. 29D

2025092509560

2027E0" 9/25E660

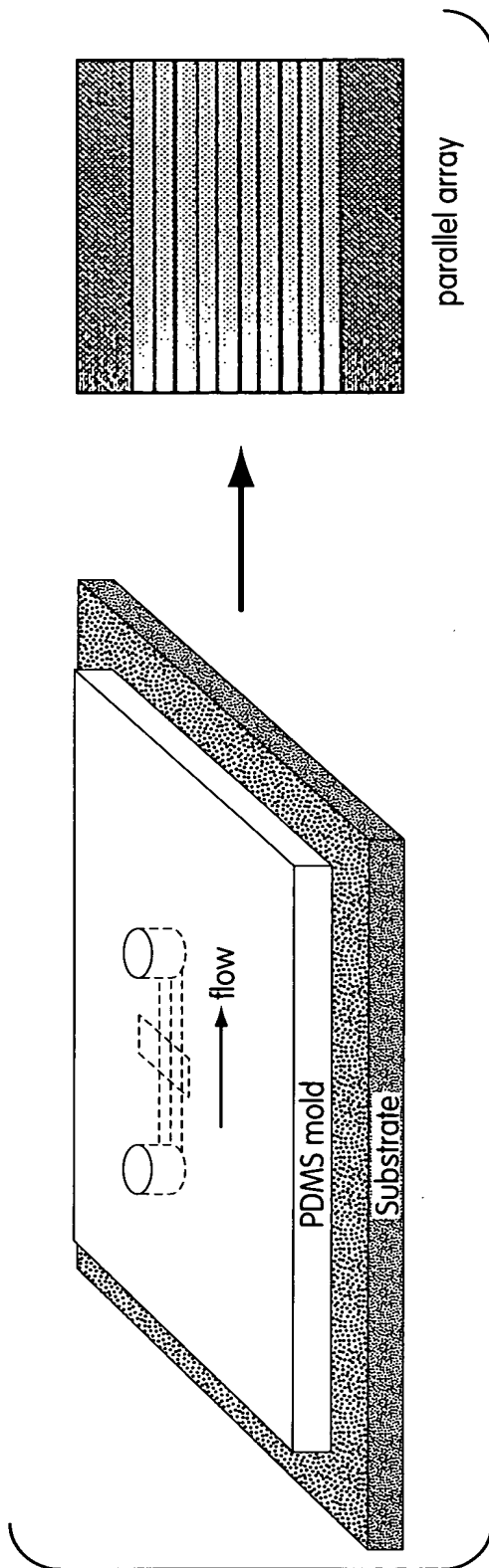

Fig. 30A

37/43

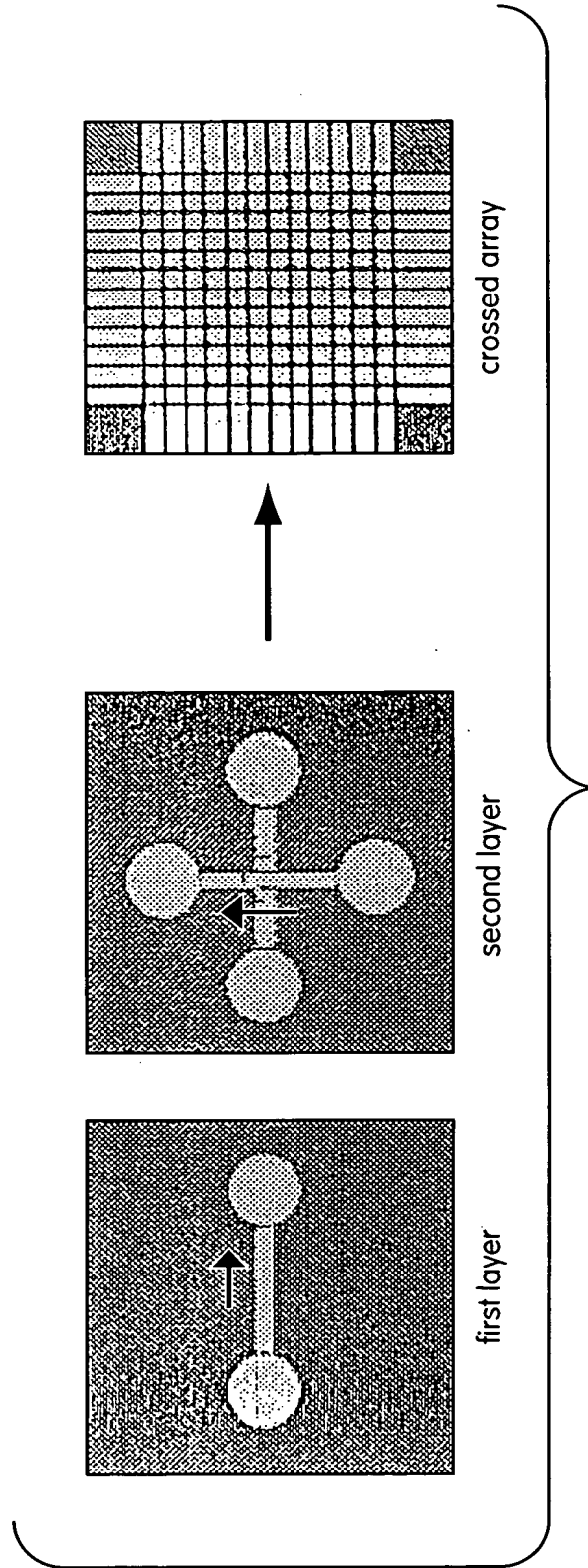

Fig. 30B

20250924 09:56:50

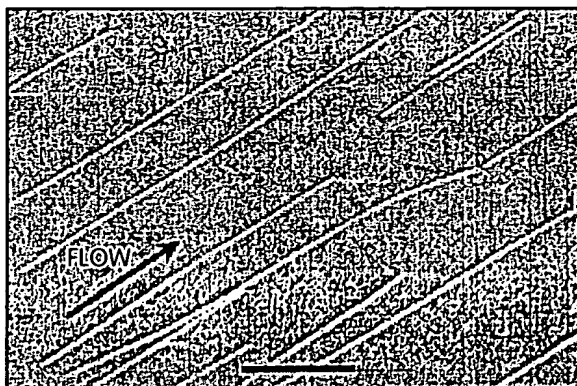

Fig. 31A

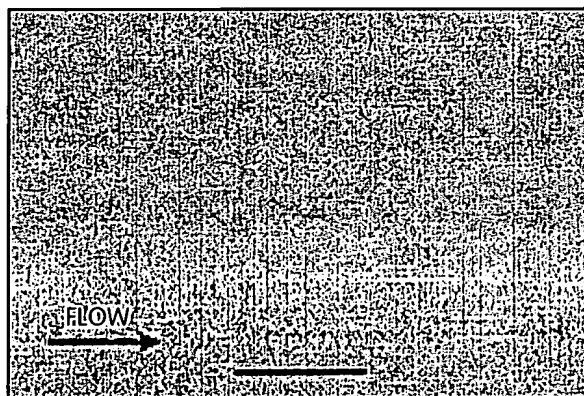

Fig. 31B

099576 9/25/60

39/43

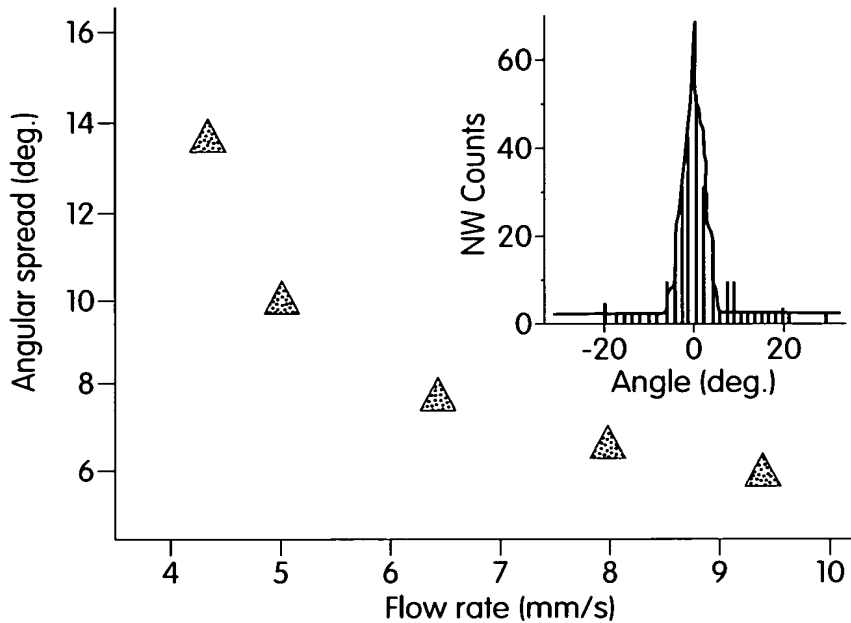

Fig. 31C

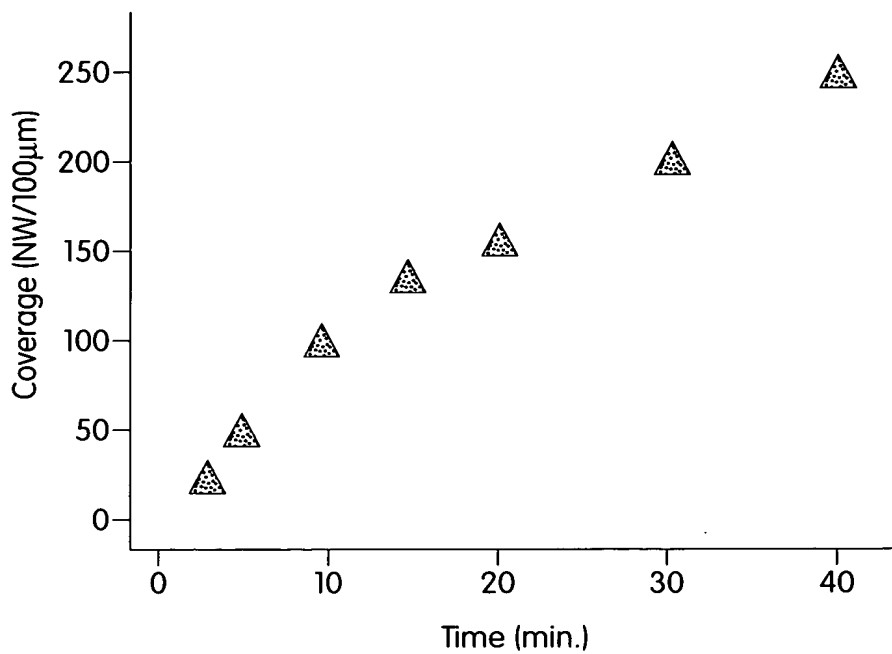

Fig. 31D

20250925E660

40/43

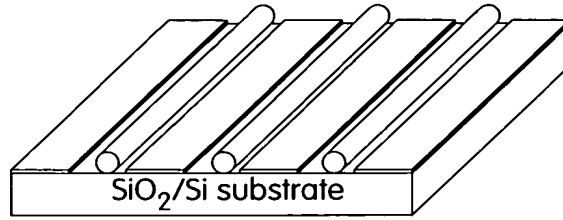

Fig. 32A

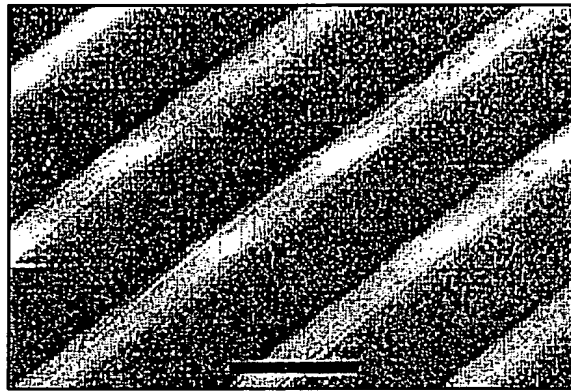

Fig. 32B

099576-031202



41/43

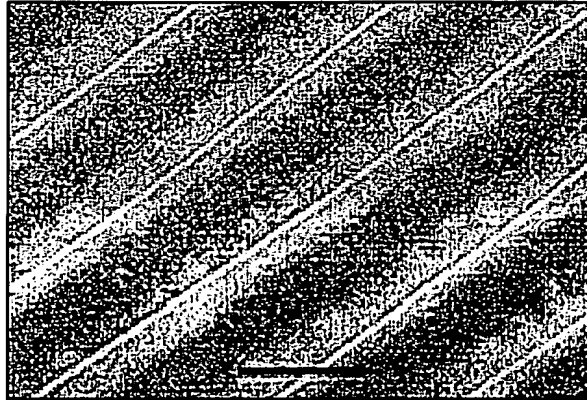

Fig. 32C

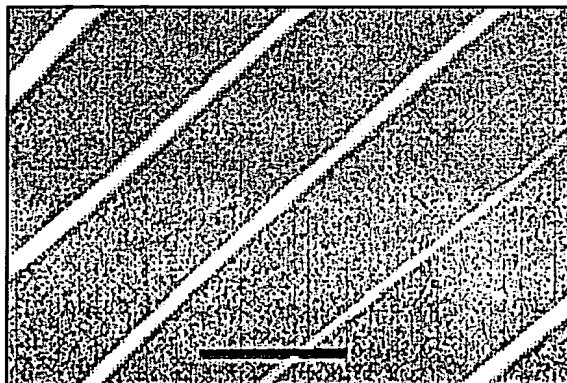

Fig. 32D

2027ED" 9/25E660

42/43

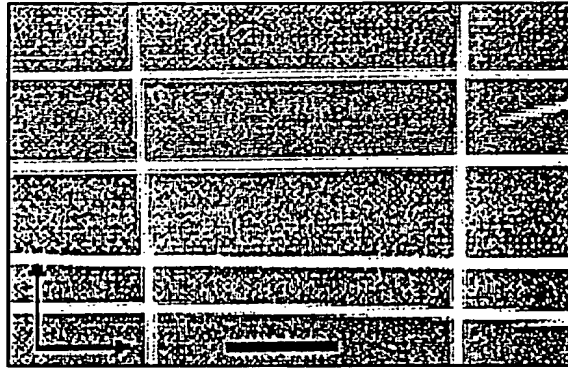

Fig. 33A

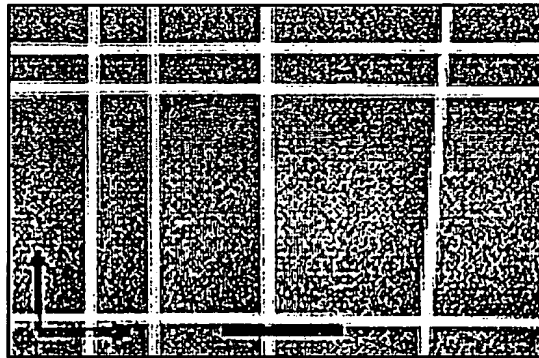

Fig. 33B

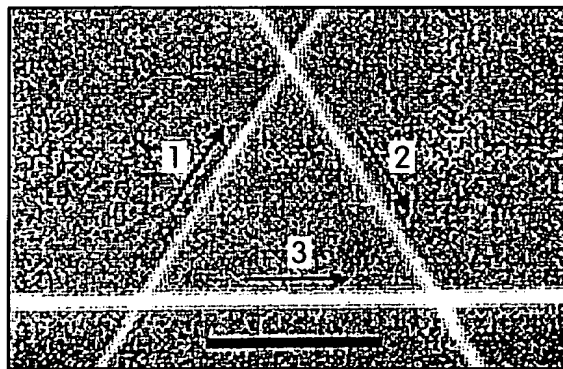

Fig. 33C

RECEIVED 9/25/66

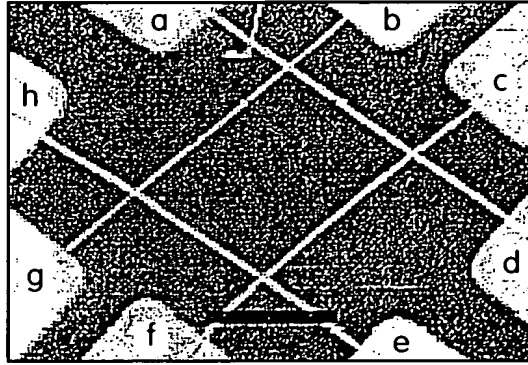

Fig. 33D

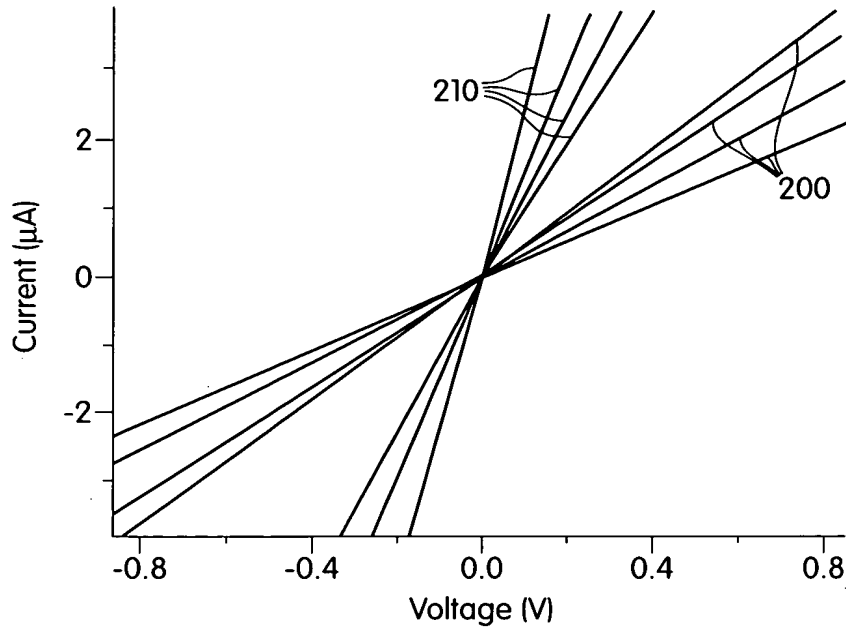

Fig. 33E

202507 94456650